

MEGA.DSS

MEGA DOUBLE SWIVEL SHACKLE

GradUp

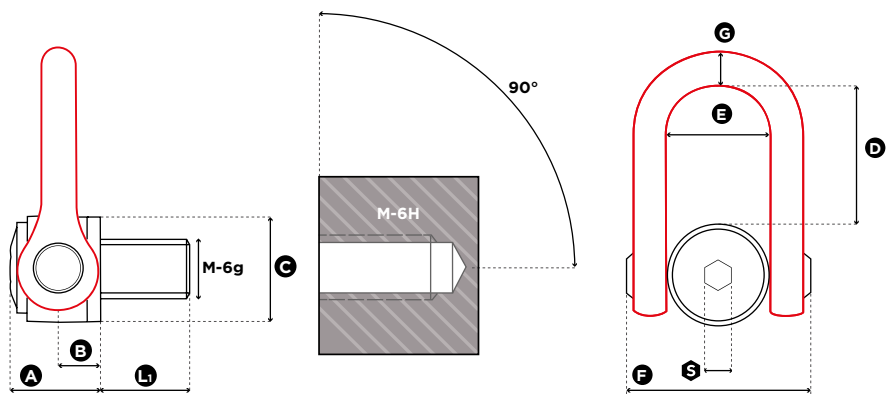

1 in = 25.4 mm

Reference	Diameter	SF 5:1 WLL (t)	SF 4:1 WLL (t)	Standard L ₁ (mm)	Torque (Nm)	S (mm)	A (mm)	B (mm)	C (mm)	D (mm)	E (mm)	F (mm)	G (mm)	Weight (kg)
MEGA.DSS M 64 UP	M 64 (x6)	26,00	33,00	100	600	36	127	64	140	195	143	278	69	42,0
MEGA.DSS M 72 UP	M 72 (x6)	28,00	35,00	110	700	36	127	64	140	195	143	278	69	43,0
MEGA.DSS M 72x4 UP	M 72 (x4)	28,00	35,00	110	700	36	127	64	140	195	143	278	69	43,0
MEGA.DSS M 80 UP	M 80 (x6)	32,00	40,00	120	800	36	127	64	140	195	143	278	69	44,5
MEGA.DSS M 90 UP	M 90 (x6)	36,00	45,00	135	900	36	127	64	140	195	143	278	69	46,5
MEGA.DSS M 100 UP	M 100 (x6)	48,00	60,00	150	1000	36	127	64	140	195	143	278	69	49,0

MEGA.DSS

MEGA DOUBLE SWIVEL SHACKLE

GradUp

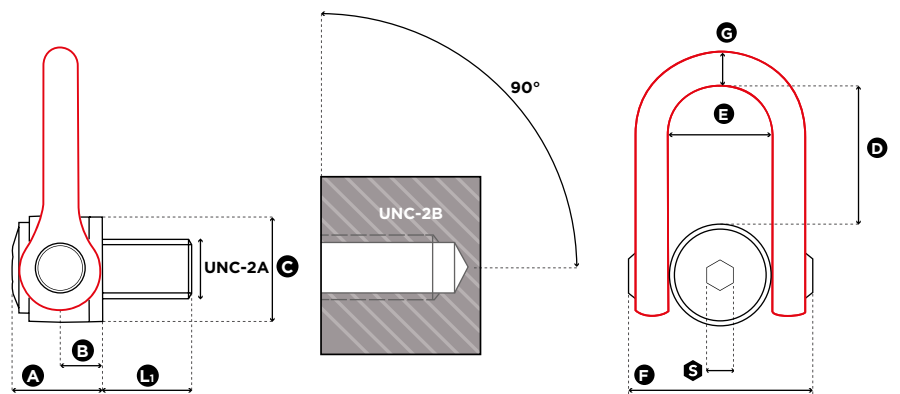

1 in = 25.4 mm

Reference	Diameter	SF 5:1 WLL (lbs)	SF 4:1 WLL (lbs)	Standard L1 (mm)	Torque (ft-lb)	S (mm)	A (mm)	B (mm)	C (mm)	D (mm)	E (mm)	F (mm)	G (mm)	Weight (kg)
MEGA.DSS U 275 UP	UNC 2" 3/4-4	60,000	75,000	105	520	36	127	64	140	195	143	278	69	42,5
MEGA.DSS U 300 UP	UNC 3" -4	64,000	80,000	115	520	36	127	64	140	195	143	278	69	43,0
MEGA.DSS U 325 UP	UNC 3" 1/4-4	72,000	90,000	125	590	36	127	64	140	195	143	278	69	44,5
MEGA.DSS U 350 UP	UNC 3" 1/2-4	76,000	95,000	135	665	36	127	64	140	195	143	278	69	46,0
MEGA.DSS U 375 UP	UNC 3" 3/4-4	80,000	100,000	145	740	36	127	64	140	195	143	278	69	47,0
MEGA.DSS U 400 UP	UNC 4" -4	88,000	110,000	150	740	36	127	64	140	195	143	278	69	49,0