

KOMATSUTM
HIGH PERFORMANCE SHOULD NOT BE OPTIONAL[©]

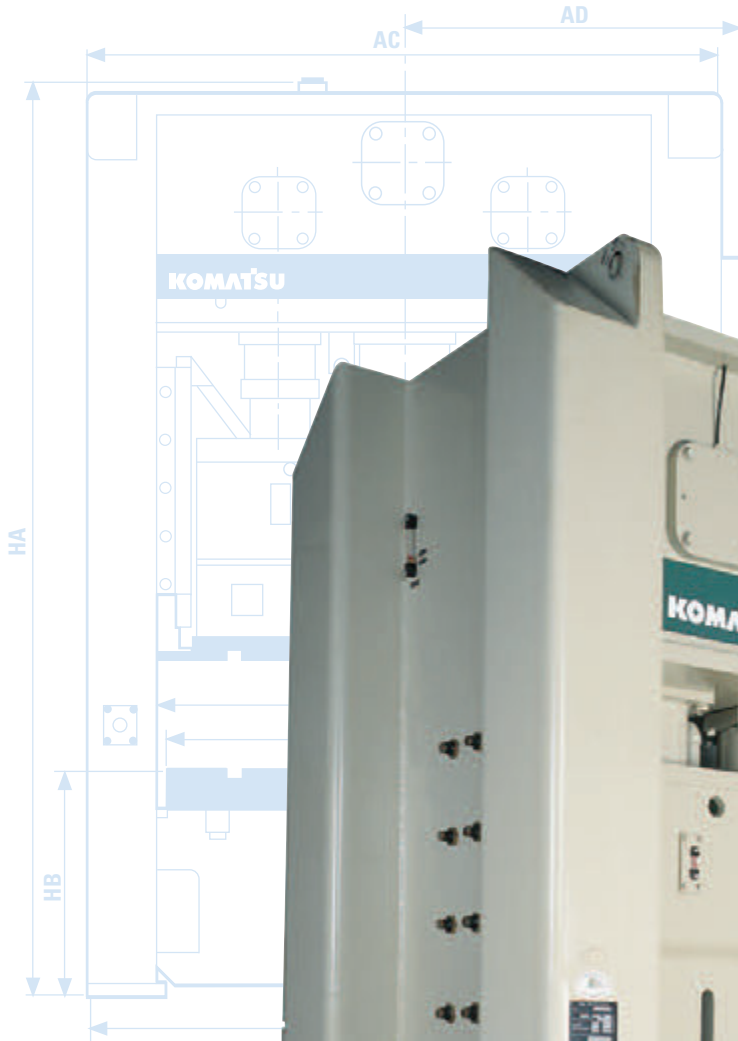

Komatsu: A Heritage of Innovation

Technological innovations that increase capacity, productivity and performance have been the hallmarks of Komatsu Press Division since its inception more than 75 years ago. Over the years, Komatsu has demonstrated a commitment to respond to customer demands and originate technologies and systems to meet the needs of a global marketplace. Today, Komatsu continues to build on its tradition of engineering excellence to create equipment that satisfies the complex demands of a competitive, highly technical and complex metal stamping industry.

1924 Komatsu leverages its technologically-innovative capabilities for heavy equipment in the mining industry to create the Komatsu Press Division and introduces its first low-maintenance stamping press, featuring the durable clutch-brake unit.

Komatsu perfects its proprietary plunger guide system, which produces 30 percent longer die life and improved part quality. The plunger guide eliminates virtually all lateral movement, allowing tighter gib tolerances and precision slide movement. This technology quickly becomes an industry standard.

Komatsu Press Division wins the Deming Prize for engineering excellence, the first Japanese press manufacturer to receive this coveted engineering award. This acknowledgment strengthens Komatsu Press Division's position as worldwide industry leader.

Komatsu's Super-series of single point gap frame presses brings product standardization to the industry with standard models, features and specifications for added value and performance.



In response to needs in the U.S. auto manufacturing market, Komatsu develops fully-automatic transfer presses that deliver high-productivity features, such as fully-automated die change and the first servo-controlled transfer feeder.

High-strength, low-alloy carbon steel and other high-strength metals replace traditional metals in production of common stamped parts. Realizing the limitations of traditional flywheel-driven powered presses in forming these materials, Komatsu launches a comprehensive development process to bring modern CNC servo technology into the stamping arena. Komatsu engineers build on years of experience in servo drive systems.

1998

Komatsu introduces the world's first standard hybrid AC servo press. Brilliantly combining the toggle link drive of

forging press models with that of modern and efficient AC servo drive systems, the new "Free Motion" of the slide motion path brings together the productivity of a mechanical press with the motion control of a hydraulic press.

Komatsu demonstrates continued engineering excellence with a series of single-point servo presses in standard models ranging from 35 to 200 metric tons as well as standard models in two-point and four-point straightside frames up to 2,500 tons—offering size and capacity that no one else can deliver. As a result of the worldwide acceptance of Komatsu AC servo presses, the company further expands its servo technology division.

Komatsu produces the world's first modular, servo-controlled, multi-slide transfer press rated at 4,200 metric tons. The press features independent slide motion control for each of the seven slides.

Komatsu creates its Automation Technology Division to develop new peripheral automation devices that enhance the technology and productivity advances of its AC servo presses. The division quickly brings new linear motor-controlled transfer feeders, high-speed tandem-line loader/unloader (H*TL) and fully programmable AC servo die cushion automation to market, making Komatsu the first to offer a fully-integrated AC servo technology system in support of customer needs.

Today

Komatsu has delivered over 4,000 AC servo presses into the global market, proof of the worldwide acceptance for the company's innovative technologies and products.



**The E2W Straight Side Press:
Designed for Superior Reliability
and Consistency.**

- Ideal for progressive, transfer or manual die operations
- True symmetrical unitized straight side frame
- Superior rigidity characteristics
- Superior off-center load characteristics
- Increased bearing slide guiding area
- Faster stopping times with actual digital display
- Higher production rates in single stroke mode
- Higher counter balance capacity
- Improved part quality
- Increased die life

**A Higher Level of Standard Equipment
for Increased Performance**

- Heavy plate, rigid frame construction
- Bolster thickness exceeds JIC standards
- Wide windows for transfer and progressive applications
- Single-piece, heavy duty cast slide, prepared for knockouts
- Precision plunger guide design
- Push-button controlled, motorized slide adjustment
- Mechanical slide lock mechanism
- Eccentric drum main drive
- Double gear reduction for greater torque capacity
- Precision oil-lubricated long 6-point gibs
- Hardened and ground helical gears
- Pneumatic counter balance
- Variable speed main motor
- High-torque wet clutch and brake
- Flywheel brake
- Quick-responding, dependable hydraulic overload protector
- Shock resistant, pendant-mounted control
- T-stand for easy set-up and operation
- 100 job memory
- Safety block with interlock

The Komatsu Warranty

When a press is designed as a system, it should be expected to perform as a system without routine tear downs for wear items (the conventional "weak link" in our competitors' presses). That's why every Komatsu E2W press comes with a One Year Unconditional Warranty on anything that rolls, slides or moves - parts and labor. Unlike other manufacturers, there is no hourly limit - your press is guaranteed to perform 3 shifts a day, 7 days a week, 365 days a year. With Komatsu systems engineering, it's possible to extract the full potential from your press, and the full revenue potential from every job.



KOMATSU™
HIGH PERFORMANCE SHOULD NOT BE OPTIONAL ©

E2W

Komatsu E2W Series Symmetrical Unitized Straight Side Power Presses

**Eccentric Drum
Main Drive**

Provides high torsional rigidity and superior strength

**True Symmetrical
Unitized Straight
Side Frame**

Cross-sectional area of sideframes exceeds many tie-rod designs

**Bolster and
Slide Machining**

JIC Standard "T" Slots
JIC Standard pin holes in bolster
Prepared for Mechanical
Knockouts - JIC
knockout pattern

T-Stand

All switches and push-buttons
necessary for ordinary press
operation, including motorized
slide adjustment

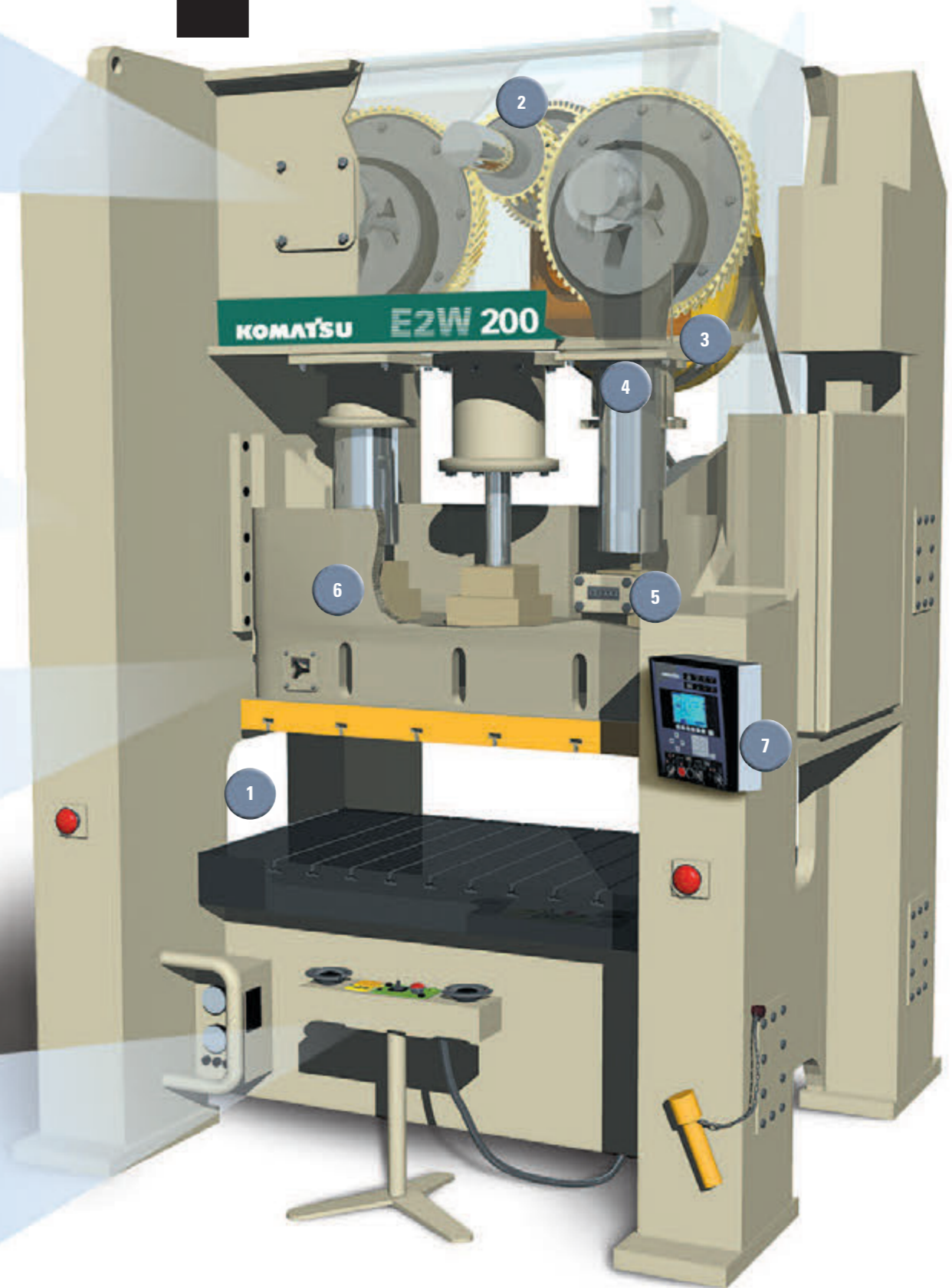

Standard Features

1 Symmetrical Unitized Frame

Engineered quality. The E2W employs an extremely rigid balanced symmetrical design. Komatsu utilizes its welding and frame design technologies to engineer the one-piece welded frame, providing the rigidity of the larger tonnage straight sides and an affordable cost. E2W also offers a wide window for transfer and progressive applications. With all this, you get the Komatsu standard of uncompromising accuracy and high part consistency stroke after stroke.

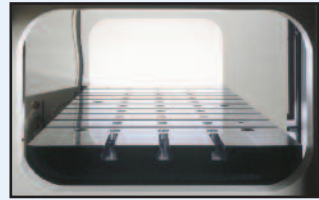

2 Double Reduction Gearing

Higher torque for maximum power transfer. Komatsu's press drive train is based around a high-quality eccentric drum for high torsional rigidity and superior strength characteristics compared to crankshaft designs. The heavy-duty drive is equipped with double reduction gearing for the eccentric drum, allowing up to 3 times the load bearing area of a similar crankshaft design.



3 Clutch and Brake

Productivity and reliability. The wet, multiple disc clutch and brake provides higher single stroke operation rates through-put while providing quicker stopping time in all modes of operation. The unit is housed in a continuous-lube, separate oil bath from the main drive, providing superior heat dissipation capabilities. No maintenance operations are normally required, other than an annual fluid change.

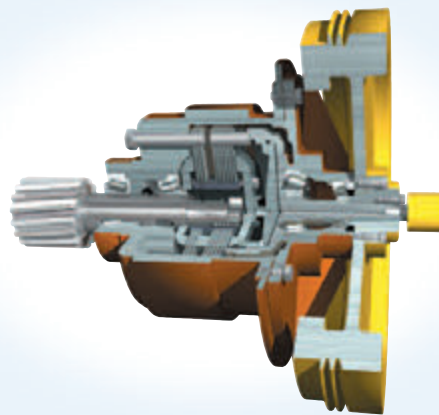

4 Plunger Guide System

Designed for high precision and less die wear. Thrust load from eccentric motion is absorbed by the plunger guide system. The plunger guide is the primary guiding force, preventing side load on the gibs. A size-specific plunger guide is engineered for each different press model, providing maximum performance for each unit. Komatsu also employs full-length gibs that capture the entire length of the slide guide. Gib tolerances are set to Komatsu's tolerances of 0.0015" nom. per gib with oil (not grease) lubrication, allowing them to last up to 200 times longer than conventional gibs. Together, the plunger guide and gib surface area of the Komatsu E2W add up to 4-5 times the guiding surface area of our nearest competitors. Less routine gib maintenance, less die wear and higher part accuracy are the positive end result, which can translate into improved profits for you.

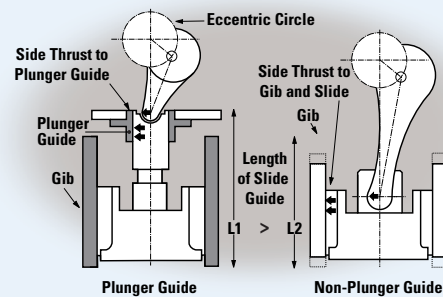

5 Slide Adjuster

Easy-to-use motorized slide adjustment. A motorized slide adjustment with digital display is standard. The die height is displayed in metric units of 0.01mm for precise slide adjustment. For extra security, the E2W press relies on precision adjustment screws and nuts rather than chains with a limit switch for overload protection in either direction. The E2W press is also equipped with a positive automatic slide adjustment lock. The unit locks in two directions, preventing changes in die setting and maintaining the consistency of the stamping quality.

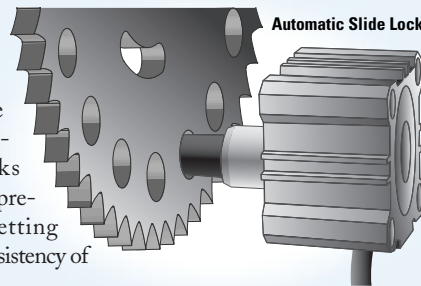

6 Hydraulic Overload Protector

Helps prevent damage to the press and dies. All Komatsu presses are equipped with a hydraulic overload protector, a standard feature that has been standard for decades, helping to protect against damage to the press or die sets. If the rated load is exceeded, the press stops automatically. Since the hydraulic pressure can be released easily, operations can be resumed smoothly even if jamming occurs.

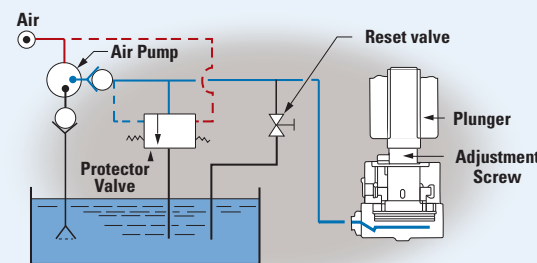

7 System Integrated Terminal

Advanced electronics technology provides user-friendly operation and outstanding reliability. The electronic press control unit is designed to provide the fastest, easiest, and most reliable control available for all press functions. Included as standard equipment on the Komatsu E2W press, the press control unit incorporates all the latest thinking in press control unit design.

- All information necessary for press set-up, start-up, operation and diagnostics is available in one display, at the touch of a button.
- Language terminology and graphics are user-friendly, easily understood by the press operator in plain view in one central location on the digital display. Display also includes plain language description of fault messages.
- The press control unit has the ability to integrate with current press room equipment, such as electronic coil feeds.
- Operator "T-stand" control interface houses all switches and push-buttons required for ordinary press set-up and operation, including buttons and key switch for slide adjustment.
- Die Data Recording function can store and retrieve data for 100 dies, including cam and fault detection angle as well as production performance. Also includes digital display of "stored" press speed and actual press speed, plus crank angle.
- Alpha-numeric entry of die name and memo data for easy cataloging and referencing.



- Digital Total Counters
 - 1-Production, re-settable
 - 1-Lot (pre-set), re-settable
- 4-Electronic rotary cams
- 1-Pneumatic air ejector with cam
- Mode Selections:
 - Off, Inch, Single Stroke, Continuous
- Optional Modes:
 - Automatic Single Stroke and Automatic Continuous (other modes are available)

Simple guidance. The press control unit displays operational procedure guidance for select press functions. Intuitive, user-friendly prompts guide press operators in a logical series of steps, for faster, more reliable press set up and operation.

Extensive use of electronics gives outstanding reliability.

- Solid-state control
- Integrated Circuits are used for all control circuits
- Cross-checking duplex circuits for clutch brake control are used on each stroke (patented)
- Increased safety, longer operation life and high reliability

Digital display for improved operation performance. Digital display of the crank angle and electronic angle detectors provide increased accuracy for press operations. Automatic operation setting and die set-up functions are easier and faster for press operators with precise, reliable settings every time. To protect the integrity of all electronic systems and provide additional safety, monitor lamps indicate status of circuits for all electronic systems and faults are detected instantly.



Optional Features

Electronic Load Monitor Load monitors are available to continuously monitor loads in all press operations, including blanking, bending, drawing, etc. The monitor also detects die overloads and underloads during operation. In addition, balanced die load is achieved by measuring the off-center-load, thus extending press and die life.

Emergency Stop Receptacle

Pneumatic Die Cushions

Vibration Isolating Pad

Slide Knockout Bars (mechanical)

Quick Die Equipment

- Hydraulic die clamps available in either lever or cylinder type.
- Hydraulic die lifters.
- Mechanical draw out rails.
- (note: re-machining of "T" slots may be required)

Photoelectric Safety Equipment

Additional Electronic Rotary Cams

Air Ejector with Cam

Die Protection System

Adjustable Hydraulic Overload

Quick Die Change Interface

Coil Line Interface

Graphic Load Monitor with Reverse Load

Warning - For protection of the operator, point-of-use guards should be used at all times. The E2W press does not include O.S.H.A. recommended point-of-protection guards.

Note - Brake monitor and control reliability. This control meets the current requirements of O.S.H.A. Standards Section 1910.217 and ANSI B11.1.

Automation Complete turn-key Komatsu designed press systems including coil lines, die carting and systems engineering tailored to your specific application.



General View

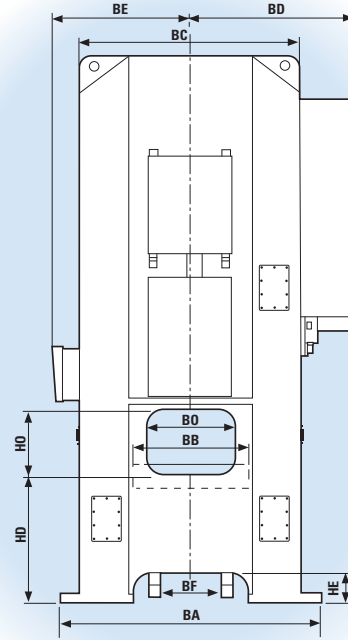
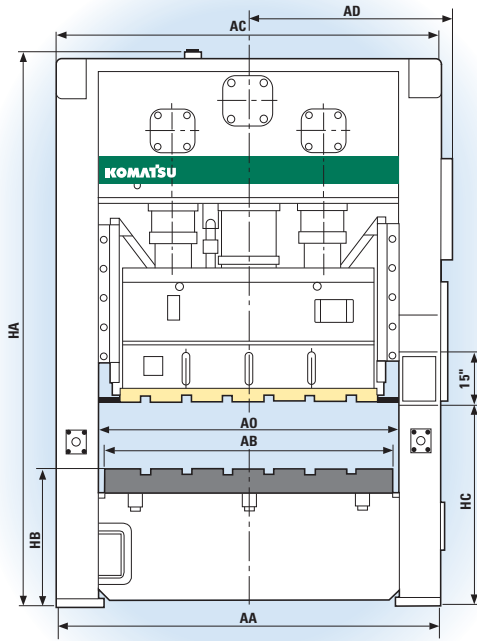

Capacity Curves

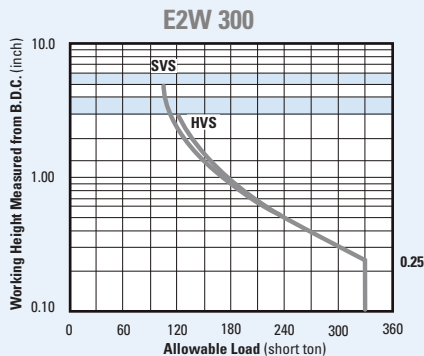
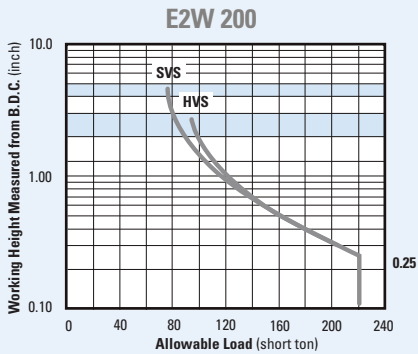
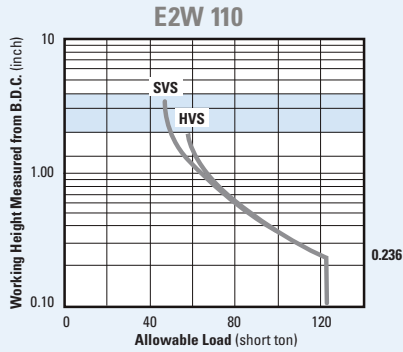

Dimensions inches

Item	Width					Depth						Height						
	AA	AB	AC	AD	AO	BA	BB	BC	BD	BE	BF	BO	HA	HB	HC	HD	HE	HO
E2W110	88.2	65.4	88.2	46.5	66.1	66.9	27.6	55.1	46.1	41.46	18.03	20.9	139.65	35.4	50.6	31.5	5.91	16.1
E2W200	108.7	84.6	108.7	56.3	85.7	74.8	42.99	63.0	50.0	45.39	21.02	33.86	165.04	39.4	57.7	35.4	7.87	19.3
E2W300	125.60	94.5	125.60	64.80	96.5	87.4	47.2	75.6	56.3	51.69	21.3	38.58	188.43	45.3	60.0	43.3	9.8	20.9

Specifications

Model	E2W110		E2W200		E2W300	
	SVS	HVS	SVS	HVS	SVS	HVS
Type						
Max. Capacity U.S. ton	121		220		330	
Rating Point	in. .236	.236	0.25	0.25	0.25	0.25
Stroke	in. 7.09	4.33	9.84	5.91	11.8	7.8
Variable Speed	s.p.m. 35-70	50-100	30-50	35-70	20-40	30-60
Shutheight	in. 15.75		19.67		23.6	
Slide Adjustment	in. 3.94		4.72		7.9	
Slide - Width	in. 55.1		72.8		82.7	
Slide - Depth	in. 20.5		43.3		47.2	
Bolster - Width	in. 65.4		84.6		94.5	
Bolster - Depth	in. 27.5		43.3		47.2	
Bolster - Thickness	in. 6.30		7.09		7.90	
Max. Upper Die/Tooling lb.	2645		4409		5511	
Main Motor	HP 15		30		50	

KOMATSUTM
HIGH PERFORMANCE SHOULD NOT BE OPTIONAL[®]

Komatsu America Industries, LLC 1701 Golf Road • Rolling Meadows, Illinois 60008
phone: 847.437.3888 • fax: 847.437.1811 • www.komatsupress.com