



Marsh Mellow[®] Springs



The Lamina Marsh Mellow® Die Spring is a proven cost saver for the metal stamping industry. Marsh Mellow® Die Springs can be used as a maintenance free replacement for costly self contained nitrogen cylinders. The unique construction elements are the secret of the spring design flexibility.

To select the proper diameter...

Deflection

■ Marsh Mellow® Die Springs may be safely compressed to 27.5% of their free length. Operating within a 27.5% compression range will increase the life of the springs. Any deflection greater than 27.5% will greatly reduce the life of Marsh Mellow® Die Springs.

■ To select the proper diameter, free length, and quantity of Marsh Mellow® Die Springs required for your application, refer to the following examples or contact a Lamina representative.

Spring Ratios

■ The spring length should not be less than 1.2 times the O.D. and not more than 1.7 times the spring O.D. (i.e. a 2" O.D. spring would range between 2.4" to 3.4" length for optimum life.

Consideration should be given to the cycle rate.

Cycle Rate

Marsh Mellow® Die Springs may be compressed up to 27.5% of their free height based upon the following C.P.M. Chart.

Maximum Percentage Compression (%)		10	15	20	25	30
30mm thru 63mm O.D.		10	15	20	25	30
1-1/8" thru 2-1/2" O.D.						
C.P.M.		200	150	125	100	75
80mm thru 150mm O.D.		10	15	20	25	30
3-1/4" thru 6" O.D.						
C.P.M.		100	75	55	45	35

Compression Set

NOTE: A compression set of up to 9% may occur over the life of the part when operated at high deflections and/or cycle rates.

The solid rubber core with hollow center and bias-ply fabric wrap are combined to meet special load and performance requirements. When designed into proper applications, Marsh Mellow® Die Springs can give up to and greater than 1 million cycles of life.

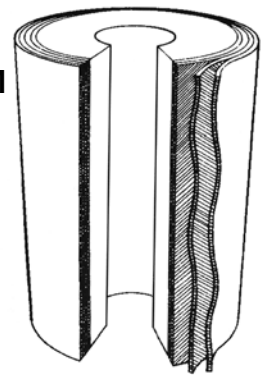

TO DETERMINE MAXIMUM FREE HEIGHT:

Ratios for all sizes, Length to O.D. should be:
Minimum 1.2
Maximum 1.7

Temperature Range

Marsh Mellow® Die Springs should be limited to use in the range: -32.5°C (-25°F) to +63°C (135°F) internal temperature. Temperatures above 63°C (135°F) will reduce the part life.

Storage

Light and heat affect the storage life of rubber springs. We recommend storing Marsh Mellow® Die Springs in low light and temperatures under 63°C (135°F).

Fluid Compatibility

Water Based Lubricants—Marsh Mellow® Die Springs are compatible with most water based fluids. Certain additives, however, can attack the compound and shorten life.

Petroleum Based Lubricants—Marsh Mellow® Die Springs are resistant, but not 100% compatible with petroleum based fluids. Occasional contact should not affect the part.

With either type lubricant, drains should be used to prevent fluids from pooling around parts.

The active life of Marsh Mellow® Die Springs is 3–5 years depending on environment and cycle time.



Marsh Mellow® Die Springs are widely accepted and used in the Automotive and Metal Stamping Industries

Typical Applications

- Die storage blocks
- Floating punches on stretch draws
- Running storage blocks (to balance uneven press ram)
- Die springs
- Pressure control on trim, flange & form dies
- Floating upper shoes on blank dies
- Substitutes for nitrogen modular press cushions
- Cam Returns

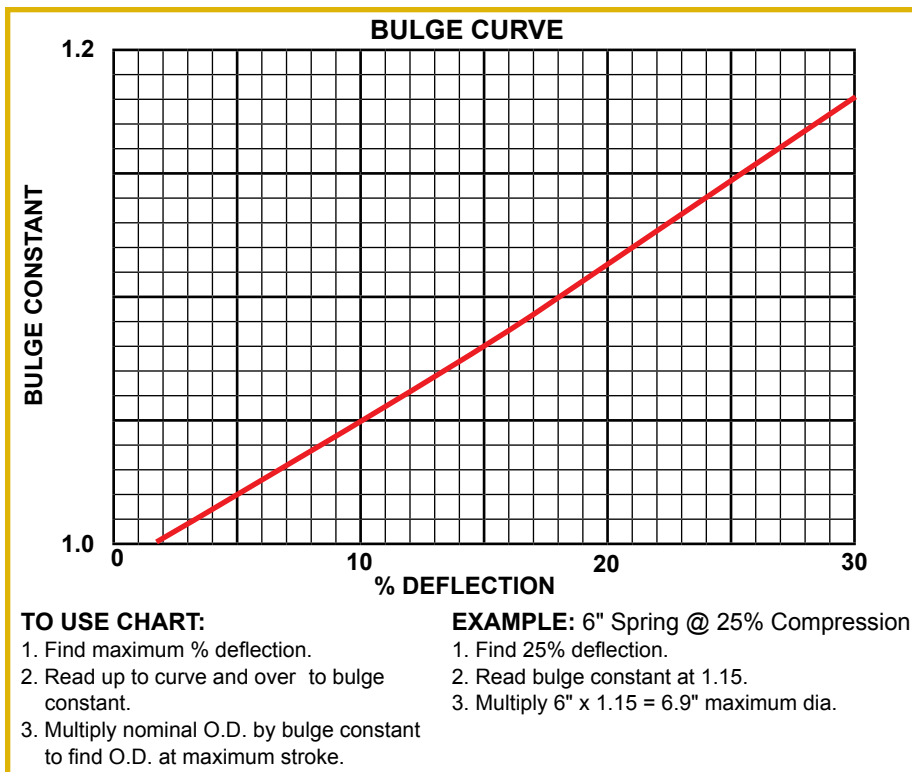

Marsh Mellow® Die Spring Selection

Most important in selecting desired diameters, close attention must be given to the bulge curve chart. Marsh Mellow® Die Springs expand cylindrically and must not come in contact with sharp surfaces (sub plates, etc.) that could cut or tear the bias ply cord. The same attention must be placed upon the surface on which the springs contact top and bottom. Marsh Mellow® Die Springs free length should not be more than 1.7 times the diameter and not less than 1.2 times the diameter. For added length, springs may be used with a guide rod or stacked with locators. (Stacking of springs does not increase force but increases total deflection.) See Figures 3 and 4 on page 12.

LOADS AS A PERCENTAGE OF DEFLECTION											
Actual O.D. x I.D.		10%		15%		20%		25%		30%	
Inch	mm	Pounds	Newtons	Pounds	Newtons	Pounds	Newtons	Pounds	Newtons	Pounds	Newtons
1-1/8" x 5/16"	30 x 8	100	445	160	712	220	979	280	1245	355	1579
1-5/8" x 5/8"	40 x 16	220	979	330	1468	465	2068	625	2780	860	3825
2" x 3/4"	50 x 20	290	1290	470	2091	650	2891	910	4048	1250	5560
2-1/2" x 3/4"	63 x 20	570	2535	920	4092	1300	5782	1780	7917	2450	10898
3-1/4" x 1"	80 x 25	925	4114	1550	6894	2050	9118	2770	12321	3710	16502
4" x 1"	100 x 25	1550	6894	2450	10898	3540	15746	4810	21395	6570	29223
5" x 1"	125 x 25	2950	13122	4600	20461	6500	28912	8850	39365	11950	53154
6" x 1"	150 x 25	4500	20016	6800	30246	9580	42612	12950	57602	17620	78374

MARSH MELLOW® DIE SPRING 1-1/8" OD x 5/16" ID				
Lamina Part Number		MM113-125	MM113-150	MM113-200
Ratio of Length to O.D.		1.11	1.33	1.78
Free Length		1.25	1.50	2.00
Maximum Compressed OD (@ Max. Compression)		1.44	1.44	1.44
Maximum Stroke 27.5%		.34	.41	.55
Total Spring Force Per 1/8" Compression Pounds	Stroke	Force	Force	Force
	0.125	120	100	80
	0.25	240	190	150
	0.375	390	300	220
	0.50	670	450	300
	0.625			410
Shaded area recommended		Unshaded area not recommended		

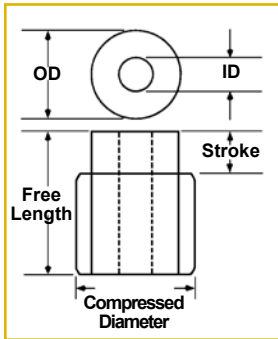

NOTES:

- Minimum recommended length-to-OD ratio is 1.2.
- Maximum recommended length-to-OD ratio is 1.7.
- Force values have been estimated.

MARSH MELLOW® DIE SPRING 30mm OD x 8mm ID					
Lamina Part Number		MM030-032M	MM030-040M	MM030-050M	MM030-063M
Ratio of Length to O.D.		1.07	1.33	1.67	2.10
Free Length		32mm	40mm	50mm	63mm
Maximum Compressed OD (@ Max. Compression)		38mm	38mm	38mm	38mm
Maximum Stroke 27.5%		8.80mm	11.00mm	13.75mm	17.33mm
Total Spring Force Per 5mm Compression Newtons	Stroke	Force	Force	Force	Force
	5	730	570	500	420
	10	1900	1400	1000	750
	15		2400	1800	1300
	20			3300	1900
Shaded area recommended			Unshaded area not recommended		

MARSH MELLOW® DIE SPRING 1-5/8" OD x 5/8" ID				
Lamina Part Number	MM163-150	MM163-200	MM163-250	MM163-325
Ratio of Length to O.D.	0.92	1.23	1.54	2.00
Free Length	1.50	2.00	2.50	3.25
Maximum Compressed OD (@ Max. Compression)	2.00	2.00	2.00	2.00
Maximum Stroke 27.5%	0.41	0.55	0.69	0.89
Total Spring Force Per 1/8" Compression Pounds	Stroke	Force	Force	Force
	0.125	210	150	80
	0.25	410	270	150
	0.375	640	430	230
	0.50	1210	600	320
	0.625		910	610
	0.75		1440	840
	0.875			1200
1.00			1700	
Shaded area recommended		Unshaded area not recommended		

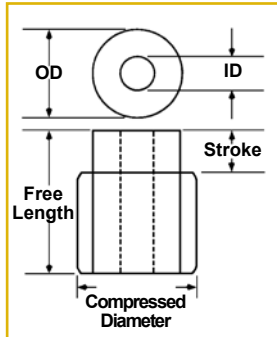

NOTES:

- Minimum recommended length-to-OD ratio is 1.2.
- Maximum recommended length-to-OD ratio is 1.7.
- Force values have been estimated.

MARSH MELLOW® DIE SPRING 40mm OD x 16mm ID				
Lamina Part Number	MM040-040M	MM040-050M	MM040-063M	MM040-080M
Ratio of Length to O.D.	1.00	1.25	1.58	2.00
Free Length	40mm	50mm	63mm	80mm
Maximum Compressed OD (@ Max. Compression)	50mm	50mm	50mm	50mm
Maximum Stroke 27.5%	11.00mm	13.75mm	17.33mm	22.00mm
Total Spring Force Per 5mm Compression Newtons	Stroke	Force	Force	Force
	5	850	610	450
	10	2000	1700	1200
	15	5500	3300	2200
	20		7000	3700
25			6900	
Shaded area recommended		Unshaded area not recommended		

MARSH MELLOW® DIE SPRING 2" OD x 3/4" ID					
Lamina Part Number	MM200-200	MM200-250	MM200-325	MM200-400	
Ratio of Length to O.D.	1.00	1.25	1.63	2.00	
Free Length	2.00	2.50	3.25	4.00	
Maximum Compressed OD (@ Max. Compression)	2.56	2.56	2.56	2.56	
Maximum Stroke 27.5%	0.55	0.69	0.89	1.10	
Total Spring Force Per 1/8" Compression Pounds	Stroke	Force	Force	Force	Force
	0.125	170	150	120	100
	0.25	400	320	230	180
	0.375	660	500	380	270
	0.50	920	700	520	380
	0.625	1270	960	670	490
	0.75	1850	1310	840	620
	0.875			1270	760
1.000				920	
Shaded area recommended			Unshaded area not recommended		

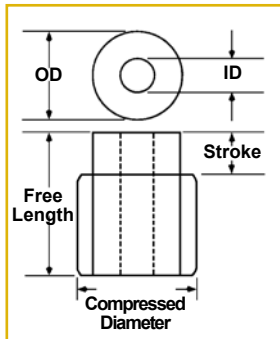

NOTES:

- Minimum recommended length-to-OD ratio is 1.2.
- Maximum recommended length-to-OD ratio is 1.7.
- Force values have been estimated.

MARSH MELLOW® DIE SPRING 50mm OD x 20mm ID					
Lamina Part Number	MM050-050M	MM050-063M	MM050-080M	MM050-100M	
Ratio of Length to O.D.	1.00	1.26	1.60	2.00	
Free Length	50mm	63mm	80mm	100mm	
Maximum Compressed OD (@ Max. Compression)	64mm	64mm	64mm	64mm	
Maximum Stroke 27.5%	13.75mm	17.33mm	22.00mm	27.50mm	
Total Spring Force Per 5mm Compression Newtons	Stroke	Force	Force	Force	Force
	5	860	540	450	320
	10	2500	1800	1200	860
	15	4900	3300	2300	1600
	20	10300	5400	3500	2500
	25		10100	5300	3500
30			8000	4900	
Shaded area recommended			Unshaded area not recommended		

MARSH MELLOW® DIE SPRING 2.50" OD x 3/4" ID					
Lamina Part Number	MM250-250	MM250-325	MM250-400	MM250-500	
Ratio of Length to O.D.	1.00	1.30	1.60	2.00	
Free Length	2.50	3.25	4.00	5.00	
Maximum Compressed OD (@ Max. Compression)	3.20	3.20	3.20	3.20	
Maximum Stroke 27.5%	0.69	0.89	1.10	1.38	
Total Spring Force Per 1/8" Compression Pounds	Stroke	Force	Force	Force	Force
	0.25	570	420	330	250
	0.50	1300	950	751	570
	0.75	2400	1570	1200	920
	1.00	5400	2600	1750	1300
	1.25		4600	2600	1750
1.50			4600	2400	
Shaded area recommended		Unshaded area not recommended			

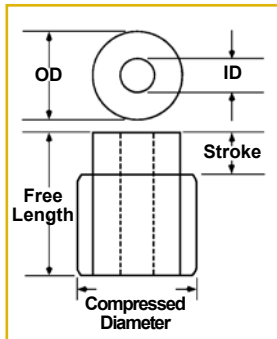

NOTES:

- Minimum recommended length-to-OD ratio is 1.2.
- Maximum recommended length-to-OD ratio is 1.7.
- Force values have been estimated.

MARSH MELLOW® DIE SPRING 63mm OD x 20mm ID					
Lamina Part Number	MM063-063M	MM063-080M	MM063-100M	MM063-125M	
Ratio of Length to O.D.	1.00	1.27	1.59	1.98	
Free Length	63mm	80mm	100mm	125mm	
Maximum Compressed OD (@ Max. Compression)	79mm	79mm	79mm	79mm	
Maximum Stroke 27.5%	17.33mm	22.00mm	27.50mm	34.38mm	
Total Spring Force Per 5mm Compression Newtons	Stroke	Force	Force	Force	Force
	5	1400	1100	880	650
	10	3700	2600	2000	1500
	15	6400	4600	3500	2300
	20	10500	7100	5000	3700
	25	20500	10000	7100	5000
	30		14600	9600	6900
35			12500	9000	
Shaded area recommended		Unshaded area not recommended			

MARSH MELLOW® DIE SPRING 3-1/4" OD x 1" ID							
Lamina Part Number	MM325-325	MM325-350	MM325-400	MM325-450	MM325-500	MM325-550	MM325-600
Ratio of Length to O.D.	1.00	1.08	1.23	1.38	1.54	1.69	1.85
Free Length	3.25	3.50	4.00	4.50	5.00	5.50	6.00
Maximum Compressed OD (@ Max. Compression)	4.16	4.16	4.16	4.16	4.16	4.16	4.16
Maximum Stroke 27.5%	.89	.96	1.10	1.24	1.38	1.51	1.65
Total Spring Force Per 1/8" Compression Pounds	Stroke	Force	Force	Force	Force	Force	Force
	0.25	800	700	600	400	320	250
	0.50	1600	1500	1260	900	630	750
	0.75	2550	2300	2000	1600	1400	1200
	1.00	4000	3500	2850	2200	1950	1700
	1.25	7000	5600	4150	3100	2600	2300
	1.50			6400	4300	3500	3000
	1.75				6500	4850	4000
2.00					7500	5200	4500
Shaded area recommended				Unshaded area not recommended			

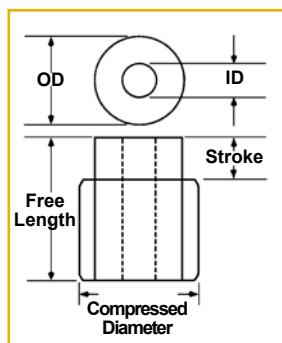

NOTES:

- Minimum recommended length-to-OD ratio is 1.2.
- Maximum recommended length-to-OD ratio is 1.7.
- Force values have been estimated.

MARSH MELLOW® DIE SPRING 80mm OD x 25mm ID					
Lamina Part Number	MM080-080M	MM080-100M	MM080-125M	MM080-140M	MM080-150M
Ratio of Length to O.D.	1.00	1.25	1.56	1.75	1.88
Free Length	80mm	100mm	125mm	140mm	150mm
Maximum Compressed OD (@ Max. Compression)	104mm	104mm	104mm	104mm	104mm
Maximum Stroke 27.5%	22.00mm	27.50mm	34.38mm	38.50mm	41.25mm
Total Spring Force Per 5mm Compression Newtons	Stroke	Force	Force	Force	Force
	5	2200	1900	1250	1100
	10	4400	3800	2500	2200
	15	8050	6200	4500	3950
	20	11700	8600	6500	5700
	25	16900	12050	8750	7400
	30	22100	15500	11000	9100
	35		23450	14050	11400
	40		31400	17100	13700
	45			24250	17350
50			31400	21000	
Shaded area recommended			Unshaded area not recommended		

MARSH MELLOW® DIE SPRING 4" OD x 1" ID									
Lamina Part Number	MM400-400	MM400-450	MM400-500	MM400-550	MM400-600	MM400-650	MM400-700	MM400-750	
Ratio of Length to O.D.	1.00	1.125	1.25	1.375	1.50	1.625	1.75	1.875	
Free Length	4.00	4.50	5.00	5.50	6.00	6.350	7.00	7.50	
Maximum Compressed OD (@ Max. Compression)	5.12	5.12	5.12	5.12	5.12	5.12	5.12	5.12	
Maximum Stroke 27.5%	1.10	1.24	1.38	1.51	1.65	1.79	1.93	2.06	
Total Spring Force Per 1/4" Compression Pounds	Stroke	Force	Force	Force	Force	Force	Force	Force	Force
	0.25	900	750	700	550	500	400	300	200
	0.50	2000	1900	1500	1400	1200	1100	800	800
	0.75	3300	2800	2500	2200	2000	1800	1500	1400
	1.00	4800	4100	3530	3100	2800	2600	2200	2000
	1.25	7100	5700	4700	4200	3700	3300	2800	2600
	1.50	11500	8200	6400	5400	4700	4200	3600	3300
	1.75	15500	12500	9000	7100	6100	5400	4500	4100
2.00		14200	15000	10000	8000	6800	5500	4900	
2.25				14000	11000	8900	6800	6000	
Shaded area recommended					Unshaded area not recommended				

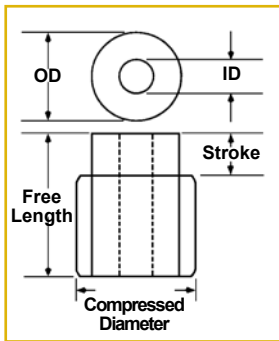

NOTES:

- Minimum recommended length-to-OD ratio is 1.2.
- Maximum recommended length-to-OD ratio is 1.7.
- Force values have been estimated.

MARSH MELLOW® DIE SPRING 100mm OD x 25mm ID									
Lamina Part Number	MM100-100M	MM100-125M	MM100-140M	MM100-150M	MM100-160M	MM100-180M	MM100-190M	MM100-200M	
Ratio of Length to O.D.	1.00	1.25	1.40	1.50	1.60	1.80	1.90	2.00	
Free Length	100mm	125mm	140mm	150mm	160mm	180mm	190mm	200mm	
Maximum Compressed OD (@ Max. Compression)	128mm	128mm	128mm	128mm	128mm	128mm	128mm	128mm	
Maximum Stroke 27.5%	27.5mm	34.38mm	38.50mm	41.25mm	44.00mm	49.50mm	52.25mm	55.00mm	
Total Spring Force Per 5mm Compression Newtons	Stroke	Force	Force	Force	Force	Force	Force	Force	Force
	5	2750	2150	1700	1600	1300	1150	1000	950
	10	5500	4300	3400	3200	2600	2300	2000	1900
	15	9700	7250	6300	5950	5150	4450	4150	3700
	20	13900	10200	9200	8700	7700	6600	6300	5500
	25	19400	14050	12200	11300	10100	8800	8250	7250
	30	24900	17900	15200	13900	12500	11000	10200	9000
	35	44650	22950	18900	17400	15750	13750	12600	11450
	40	64400	28000	22600	20900	19000	16500	15000	13900
	45		46200	29200	25900	22750	19250	17500	15950
	50		64400	35800	30900	26500	22000	20000	18000
	55				47650	35200	26450	23700	21450
60				64400	43900	30900	27400	24900	
Shaded area recommended					Unshaded area not recommended				

MARSH MELLOW® DIE SPRING 5" OD x 1" ID									
Lamina Part Number	MM500-500	MM500-550	MM500-600	MM500-650	MM500-700	MM500-750	MM500-800	MM500-850	MM500-900
Ratio of Length to O.D.	1.0	1.1	1.2	1.3	1.4	1.5	1.6	1.7	1.8
Free Length	5.00	5.50	6.00	6.50	7.00	7.50	8.00	8.50	9.00
Maximum Compressed OD (@ Max. Compression)	6.40	6.40	6.40	6.40	6.40	6.40	6.40	6.40	6.40
Maximum Stroke 27.5%	1.38	1.51	1.65	1.79	1.93	2.08	2.20	2.34	2.48
Total Spring Force Per 1/4" Compression Pounds	Stroke	Force	Force	Force	Force	Force	Force	Force	Force
	0.25	1400	1300	1000	900	700	600	400	300
	0.50	3000	2700	2200	2000	1700	1600	1300	1100
	0.75	4600	4000	3400	3200	2800	2700	2200	1900
	1.00	6400	5600	4800	4400	3900	3700	3100	2700
	1.25	8700	7500	6300	5800	5200	4800	4100	3500
	1.50	11700	9900	8100	7300	6600	6000	5200	4400
	1.75	17000	13500	10500	9100	8000	7400	6300	5700
	2.00	24500	17900	13800	11500	9700	9000	7500	6900
	2.25			19000	15500	12500	11000	9000	8100
2.50				20500	16300	13700	10800	9700	
2.75					21500	17300	13300	11500	
3000 Shaded area recommended				Unshaded area not recommended					

NOTES:

- Minimum recommended length-to-OD ratio is 1.2.
- Maximum recommended length-to-OD ratio is 1.7.
- Force values have been estimated.

MARSH MELLOW® DIE SPRING 125mm OD x 25mm ID									
Lamina Part Number	MM125-125M	MM125-140M	MM125-150M	MM125-160M	MM125-180M	MM125-190M	MM125-200M	MM125-215M	MM125-225M
Ratio of Length to O.D.	1.00	1.12	1.20	1.28	1.44	1.52	1.60	1.72	1.80
Free Length	125mm	140mm	150mm	160mm	180mm	190mm	200mm	215mm	225mm
Maximum Compressed OD (@ Max. Compression)	161mm	161mm	161mm	161mm	161mm	161mm	161mm	161mm	161mm
Maximum Stroke 27.5%	34.38mm	38.50mm	41.25mm	44.00mm	49.50mm	52.25mm	55.00mm	59.13mm	61.88mm
Total Spring Force Per 5mm Compression Newtons	Stroke	Force	Force	Force	Force	Force	Force	Force	Force
	5	3900	3400	3000	2750	2500	2250	2000	1750
	10	7800	6800	6000	5500	5000	4500	4000	3500
	15	12650	11150	10000	9350	8000	7600	7250	6650
	20	17500	15500	14000	13200	11000	10700	10500	9800
	25	23750	20350	18750	17250	15000	14100	13250	12400
	30	30000	25200	23500	21300	19000	17500	16000	15000
	35	39000	32350	29000	26400	23600	21350	19750	18000
	40	48000	39500	34500	31500	28200	25200	23500	21000
	45	74000	49250	43250	38500	32600	29850	27500	25000
	50	100000	59000	52000	45500	37000	34500	31500	29000
	55			76000	55500	44500	41050	36750	33000
	60			100000	65500	52000	47600	42000	37000
65					66750	54800	49750	43500	
70					81500	62000	57500	50000	
Shaded area recommended				Unshaded area not recommended					

MARSH MELLOW® DIE SPRING 6" OD x 1" ID							
Lamina Part Number	MM600-600	MM600-650	MM600-700	MM600-750	MM600-800	MM600-900	MM600-1000
Ratio of Length to O.D.	1.0	1.08	1.17	1.25	1.33	1.50	1.67
Free Length	6.00	6.50	7.00	7.50	8.00	9.00	10.00
Maximum Compressed OD (@ Max. Compression)	7.63	7.63	7.63	7.63	7.63	7.63	7.63
Maximum Stroke 27.5%	1.65	1.79	1.93	2.06	2.20	2.48	2.75
Total Spring Force Per 1/4" Compression Pounds	Stroke	Force	Force	Force	Force	Force	Force
	0.25	1400	1300	1100	900	800	7580
	0.50	3400	3100	2800	2400	2200	2150
	0.75	5400	5000	4500	4000	3700	3500
	1.00	7500	6900	6100	5500	5100	4700
	1.25	10000	9000	8200	7300	6700	6100
	1.50	12900	11200	10100	9100	8300	7500
	1.75	16500	14200	12500	11100	10100	9000
	2.00	22000	18300	15600	13500	12100	10800
	2.25	30000	24300	19500	16500	14700	12800
2.50		31600	25200	20300	17800	15200	
2.75			32000	26600	22100	18400	
3.00				38000	28000	22600	
Shaded area recommended				Unshaded area not recommended			

NOTES:

- Minimum recommended length-to-OD ratio is 1.2.
- Maximum recommended length-to-OD ratio is 1.7.
- Force values have been estimated.

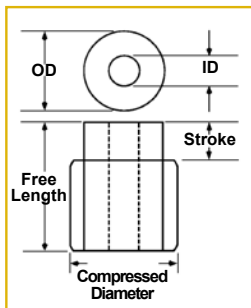

MARSH MELLOW® DIE SPRING 150mm OD x 25mm ID						
Lamina Part Number	MM150-150M	MM150-160M	MM150-180M	MM150-190M	MM150-200M	MM150-250M
Ratio of Length to O.D.	1.00	1.07	1.20	1.27	1.33	1.67
Free Length	150mm	160mm	180mm	190mm	200mm	250mm
Maximum Compressed OD (@ Max. Compression)	192mm	192mm	192mm	192mm	192mm	192mm
Maximum Stroke 27.5%	41.25mm	44.00mm	49.50mm	52.25mm	55.00mm	68.75mm
Total Spring Force Per 5mm Compression Newtons	Stroke	Force	Force	Force	Force	Force
	5	6000	5500	5000	4500	4000
	10	12000	11000	10000	9000	8000
	15	18500	16500	15000	14000	13000
	20	25000	22000	20000	19000	18000
	25	32500	29500	26500	25500	21500
	30	40000	37000	33000	32000	25000
	35	49000	46000	39500	37500	32500
	40	58000	55000	46000	43000	40000
	45	75000	66000	53500	50500	47500
	50	92000	77000	61000	58000	55000
	55	123500	106500	76500	69500	58500
	60	155000	136000	92000	81000	62000
	65			116000	102000	83500
	70			140000	123000	105000
75					130000	
80					155000	
Shaded area recommended				Unshaded area not recommended		

Installation Instructions

1. Hole or Pocket Size

Marsh Mellow® Die Springs were designed to insure proper fit in specific size holes or spring pockets. Insure that the hole or spring pocket is the proper size and that the Marsh Mellow® Die Spring is centered. See bulge curve on page 3.

2. Locating Stud

Threaded studs can be used as locators.

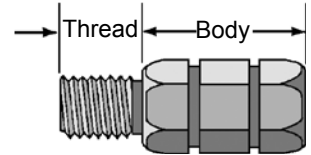

Threaded Studs Available

(Press-fit) into Marsh Mellow® Die Springs to order ad suffix "T" i.e. for stud

MARSHMELLOW I.D.	PART NUMBER	THREAD LENGTH	BODY LENGTH	OVERALL LENGTH
*8mm 5/16"	T-Stud-M6-1.0 T-Stud-1/4-20	12.5mm 1/2"	38mm 1-1/2"	50.5mm 2"
*16mm 5/8"	T-Stud-M10-1.5 T-Stud-3/8-16	16mm 5/8"	38mm 1-1/2"	54mm 2-1/8"
*20mm 3/4"	T-Stud-M12-1.75 T-Stud-1/2-13	20mm 3/4"	38mm 1-1/2"	58mm 2-1/4"
*25mm 1"	T-Stud-M20-2.5 T-Stud-3/4-10	30mm 1"	50mm 2"	801mm 3"

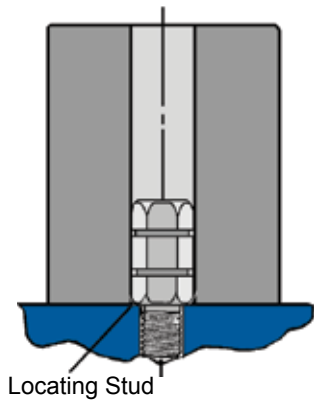

*Metric studs will be used with metric sized Marsh Mellow® Die Springs unless otherwise requested.

Regarding installing studs in Marsh Mellow® Die Springs:

The body length of the stud should never exceed 50% of the Marsh Mellow® Die Spring free length.

If such a condition does arise, the stud must be altered to allow for compression.

STACKING

3. Using Locators

Locators can be made from washers and should fit closely around the rod. O.D. pocket must accommodate bulge growth.

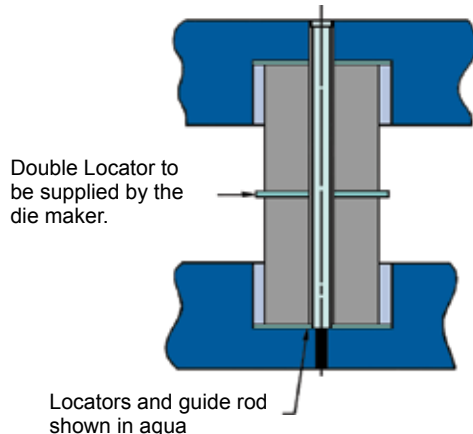

4. Using Guide Rods

Guide rods are recommended when stacking Marsh Mellow® Die Springs.

Guide rods, washers and sleeves are supplied by the die maker.

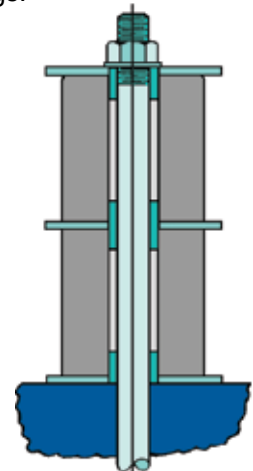

Application Requirements

Considerations for the selection of individual Marsh Mellow® Die Springs

- 1 Determine the force required to blank, form, hold or strip the part. Remember—die design is an art, not an exact science. At times more force may be necessary than originally calculated. We recommend an upward adjustment over determined force (this allows for the set that a spring will take over it's lifetime and any additional friction).
- 2 Determine the working stroke required to make the part.
- 3 Determine the die open clearance.
- 4 Determine the working area.
- 5 Determine the strokes per minute.

- 6 Determine if there are restrictions on the outside diameters (because of the bulge—expansion of the spring when compressed (see the bulge curve on page 3) due to restraints, interferences, flat and smooth mounting/striking surfaces, etc.

Please Note:

- 7 The Marsh Mellow® Die Spring is made from a Rubber Compound – its physical properties deteriorate over time. Depending on temperature, light, ratios, deflection, cycle rate, etc. the spring begins to diminish after three years of life. Heat is an enemy of rubber, either heat generated from compression of the spring or operating environment temperatures.

The active life of a Marsh Mellow® Die Spring is 3 – 5 years depending on operating conditions.

Application Ideas:

Marsh Mellow® Die Springs are designed to replace certain standard size coil die springs and nitrogen cylinders.

1. Die storage blocks. SEE EXAMPLE 1.
2. Running storage blocks (which will balance uneven press ram thereby improving part quality).
3. Floating upper shoe on blank dies (improving quick die change). SEE EXAMPLE 2.
4. Floating punches on inverted stretch draws (replacing nitrogen cylinders).

In addition, the larger diameter parts can exert forces from 1900 to 155,000 newtons (Lbs.) each, and are an extremely effective alternative to costly nitrogen cylinders as in CAM returns.

5. Cam returns. SEE EXAMPLES 3 & 4.
6. Die springs (on pads eliminating costly spring pockets).
7. Pressure control on trim, flange and form dies.
8. Replace nitrogen modular press cushions on OBI presses.

EXAMPLE 1

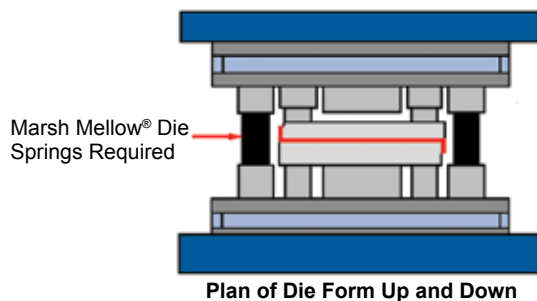

EXAMPLE 2

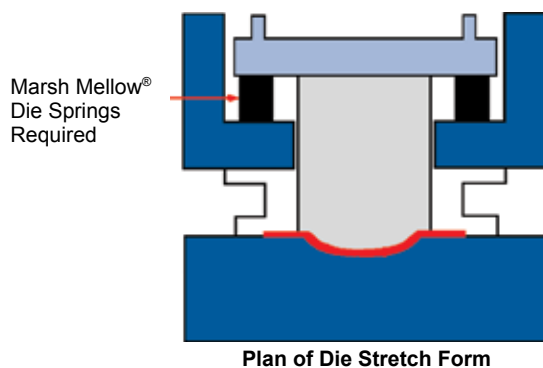

EXAMPLE 3

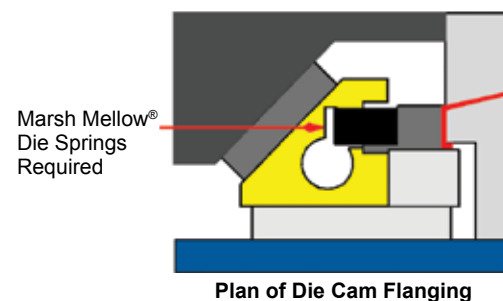

EXAMPLE 4

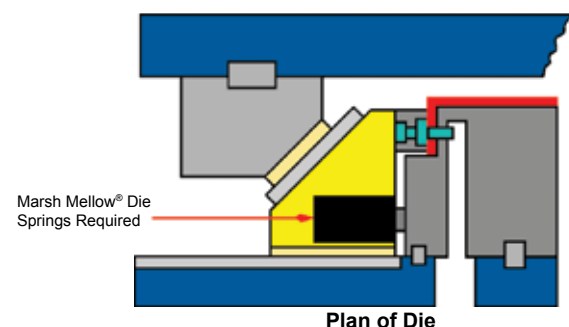

Cam Returns are an excellent application for Marsh Mellow® Die Springs. As the Marsh Mellow® Die Springs eliminate the sometimes awkward long coil springs required to produce enough pressure to return the cams

Note: Storage Blocks to be spaced as far apart as practical.

NOTES

OTHER LAMINA PRODUCTS

Lamina supplies the most extensive selection of springs and pressure control devices used in die sets, molds, fixtures and machines. Among the products Lamina stocks are the following:



Danly™ DieMax XL® Die Springs

- ◆ Yields reliable, trouble-free performance
- ◆ High tensile strength chrome silicon material
- ◆ Optimal rectangular wire design



MRO Utility Springs

- ◆ Engineered for durability
- ◆ Unlimited applications for general utility and industry
- ◆ Available in a variety of compression and extension springs

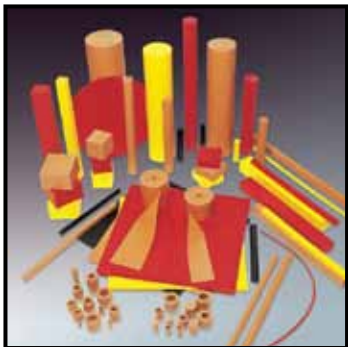

Formathane® Urethane

- ◆ Specially formulated for metalforming
- ◆ Greater abrasion resistance
- ◆ Higher pressures with added durability

Commitment to Quality & Customer Satisfaction

Dayton Lamina is a leading manufacturer of tool, die and mold components for the metal-working and plastics industries. As a customer-focused, world-class supplier of choice, we provide the brands, product breadth, distribution network and technical support for all your metal forming needs.

Our goal is to give our customers the most innovative and value-added products and services.



DAYTON Lamina™

a MISUMI Group Company



Lamina® LEMPCO

*Dayton Lamina's line of Danly products is available only to North America.

www.daytonlamina.com