

JIS SPRINGS



Anchor Danly
The Brands You Trust

JIS SPRINGS

SERVICE WE DELIVER AND QUALITY YOU CAN DEPEND ON

ANCHOR DANLY is a leading manufacturer of die and die component products supplied globally to the parts forming industry. Backed by years of tool and die experience, quality and innovation are some of the reasons why our name is respected throughout the world. We have taken the lead role in creating and bringing new products to customers and helping them find solutions that improve their operations. Based on the capabilities **ANCHOR DANLY** offers, we can help you to meet the demands of quick deliveries, technical support, quality products and competitive prices. **ANCHOR DANLY** and its' broad distribution channels and direct sales personnel will assist you in any way to make your product a better and more profitable one.

Whether standard or customized products, with our years of experience, customers can be sure the products they receive will meet their expectations for reliability and dependable performance. We understand the demanding schedules of die builders and production personnel and have developed efficient manufacturing processes to shorten product lead times as well as put inventory on our shelves so you can have it in your facility when you need it. Put the **ANCHOR DANLY** network to work for you. We've got the service you've been looking for.

Included in our full line offering are both inch and metric size die sets and die components that are designed to numerous die standards including ISO, NAAMS, JIS and many large automotive and appliance manufacturers' standards. The complete product offering includes:

- Accu-Bend Rotary Benders
- Air Presses
- Cams
 - Aerial & Diemount Cams
 - Box Cams
 - Roller Cams
 - Wide Cams
- Die Accessories
- Die Sets
 - Plain & Ball Bearing Sets
 - Catalog Ball Bearing Sets
 - Wear Plate Sets
 - Cast Sets
- Ejector Boxes
- Guide Posts & Bushings
 - Plain & Ball Bearing Styles
 - Steel, Bronze, Bronze-Plated &
 - Self-Lubricating Bushings
 - Lempoloy Bushings
 - Special Pins, Bushings & Retainers
- Hydraulics
 - Electronic Die Setters
 - Die Separators
 - Drill & Tap Equipment
 - Hydraulic Motors
- In-Die Tapping Units
- Machined and Cut Ground Plate
 - Adapter Plates
 - Bolster Plates
 - 1020, 1045 & 4140 materials
- Manufacturing Services
 - CNC Machining
 - Blanchard Grinding
 - Stress Relieving
 - Die Set Repair
- Mold Components
 - Bronze Plated & Self-Lubricated Bushings
 - Leader Pins
 - Bronze & Bronze Plated Wear Strips & Ways
- Punches, Buttons & Retainers
- Reliance Fabrications
 - Custom Fabrications
 - Robotic Welding
 - Aluminum & Steel Fixture Bases
- Springs
 - DieMax L Inch Series Springs
 - DieMax XL Series ISO Springs
 - JIS Series Springs
 - Custom Heavy Duty Springs
 - Marsh Mellow Springs
 - Formathane Urethane
 - Kaller Gas Springs
 - Utility & Disc Springs
- Wear Products
 - Plates, Strips, Gibs & Blocks
 - Steel, bronze, Bronze-Plated and Self-Lubricating Materials

JIS Springs

TABLE OF CONTENTS

PAGE NUMBER

General Information	2
Spring Selection Steps	4
JIS Standard	6
Spring Accessories	26
Quote Sheet	27

Identi Springs

Have you standardized on non-ISO coded spring colors? Try our Identi spring series striped to make conversion to ISO easier. The Identi springs are available in 4 load ratings including Light (Blue), Medium (Red), Heavy (Gold) and Extra Heavy (Green) loads.



ISO Springs

ISO die springs are manufactured and color coded to the ISO Standard. The product line consists of four load ratings: Light, Medium, Heavy and Extra Heavy loads.



General Information

Metric springs conform to the Japanese Industrial Standards (JIS)

For years, we have manufactured high quality springs in all standard ISO sizes and a series of round wire springs, following ISO 9002 quality standards – all in inch sizes. With the springs in this catalog, we are making available a line of true-metric springs, in all the standard JIS sizes and colors.

This extension of the spring line gives more options to customers with exacting requirements, and best of all, makes them available from the same reliable source as the inch springs. If you need help finding a specific heavy-duty compression spring, give us a call.



**EXTRA
LIGHT LOAD**
Yellow
Color Coded



LIGHT LOAD
Blue
Color Coded



MEDIUM LOAD
Red
Color Coded



HEAVY LOAD
Green
Color Coded



**EXTRA
HEAVY LOAD**
Brown
Color Coded

General Information

Quick Tips to Extend the Life of Your JIS Springs

Use the longest spring possible:
Spring life is directly related to travel distance as a percent of spring length:

Less travel = longer life.

Protect the spring wire surface:
The secret to long life is the integrity of the wire surface. Fractures occur when normal spring stresses combine with surface imperfections to create a stress concentration. In order to minimize damage to the spring surface, follow these suggestions:

- 1) Train employees on the value of protecting the wire surface.
- 2) Use a spring cage to protect and keep the spring clean of debris.
- 3) Do not alter the spring – surface integrity is key.

Purchase springs to the correct length:

The ends of each spring are closed and ground square to assure that the spring will stand on either end and provide a maximum bearing surface.



Keep the force and the spring movement linear:
A direct force against the spring, precise alignment of spring pockets, and the proper support to keep the spring straight, all ensure long life and maximize spring efficiency.

Torsion, bending (due to lack of support), or diagonal pressure on the spring will shorten the life of the spring.

- 1) Use a spring cage, retainer or alignment rod to support the spring and keep it straight – this is especially important for springs whose length is more than 4 times the diameter.
- 2) Flat surfaces in the spring pockets provide the best support and keep the spring standing straight.

Keep the springs under pre-load:
Spring retainers not only simplify die construction by holding the springs in place, they also keep the springs under pressure to reduce shock.

- 1) The amount of pre-load should be at least 1/6 total travel; more pre-load is better as it reduces travel.
- 2) Faster die operations require greater pre-load to minimize failure due to shock.

Spring Maintenance:
Replace all springs at the same time to keep the die balanced and keep it working like new. Over time, springs lose their force. Replacing springs in just one area of the die may cause an imbalance in the die. The symptom will be a sudden increase in wear on punches, guide pins, bushings and a decrease in spring life.



Coilers - Using the latest in CNC coiling technology, springs are produced with much better predictability and consistency in performance, rates and lengths.



SPC Quality Assurance - Using SPC software, operators insure that every production process meets our high quality standards.



Computer Controlled Spring Testing - Utilizing custom software, spring testers track and verify consistency in spring dimensions and rates.

Spring Selection Steps

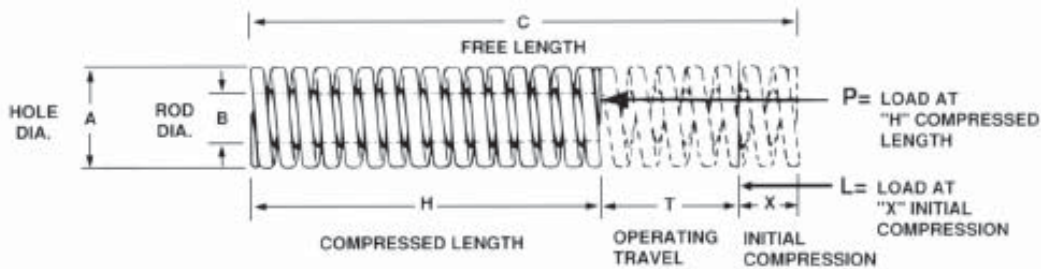

If the diameter and length are known, turn directly to dimension tables on pages 6 through 25 to select springs with desired total load.

If diameter and length are not known, use the following seven spring selection steps and refer to the rate column of the dimension tables for spring selection.

In determining the length of a spring, it should be remembered that maximum delivered spring load is

obtained by selecting longer springs. For best economy and saving of space, choose Extra Light, Light, Medium or the Heavy Load spring having a free length equal to six times the travel, or an Extra Heavy Load spring having a free length equal to eight times the travel. If ratios lower than these are used because of height limitations, the number of springs required will be substantially increased.

Step 1

Estimate the level of production required of the die – short run, constant production, etc.

Step 2

Determine compressed spring length “H” and operating travel “T” for the die layout.

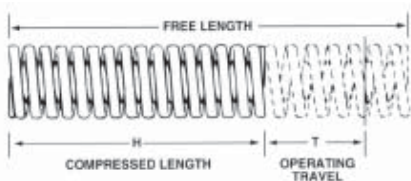

Step 3

Determine free length “C” as follows:
Decide which load classification the spring should be selected from – Extra-Light, Light, Medium, Heavy, or Extra-Heavy Load. Then choose the figure nearest the compressed length “H” required by the die design from the chart on page 5. Read corresponding “C” (free length).

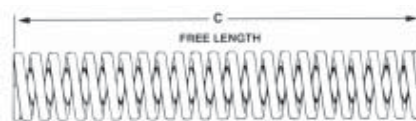

Step 4

Estimate total initial spring load “L” required for all springs when springs are compressed “X” millimeters.

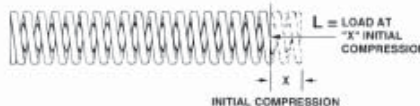

Step 5

Determine “X” (initial compression) by using the following formula:

$$X = C - H - T$$

Step 6

Determine “R” (total rate for all springs in newtons per millimeter) by using the following formula:

$$R = \frac{L}{X}$$

Step 7

Select springs as follows:

1. The free length “C” must comply with the length determined in Step 3.
2. Divide “R” in Step 6 by the number of springs to be used (if known) in order to get the rate per spring. Then refer to the following pages for the catalog number of springs having the desired rate. If the number of springs is not known, divide “R” from Step 6 by the rate of the spring you select for the correct number of springs.

Spring Selection Steps

THIS CHART CONVERTS COMPRESSED LENGTHS TO FREE LENGTHS															
C Free Length (mm)	EXTRA LIGHT LOAD			LIGHT LOAD			MEDIUM LOAD			HEAVY LOAD			EXTRA HEAVY LOAD		
	H-COMPRESSED LENGTH (mm)			H-COMPRESSED LENGTH (mm)			H-COMPRESSED LENGTH (mm)			H-COMPRESSED LENGTH (mm)			H-COMPRESSED LENGTH (mm)		
	Long Life 40%	Average Life 45%	Maximum Deflection 50%	Long Life 32%	Average Life 36%	Maximum Deflection 40%	Long Life 25.6%	Average Life 28.8%	Maximum Deflection 32%	Long Life 19.2%	Average Life 21.6%	Maximum Deflection 24%	Long Life 16%	Average Life 18%	Maximum Deflection 20%
20	8.0	9.0	10.0	6.4	7.2	8.0	5.1	5.8	6.4	3.8	4.3	4.8	3.2	3.6	4.0
25	10.0	11.3	12.5	8.0	9.0	10.0	6.4	7.2	8.0	4.8	5.4	6.0	4.0	4.5	5.0
30	12.0	13.5	15.0	9.6	10.8	12.0	7.7	8.6	9.6	5.8	6.5	7.2	4.8	5.4	6.0
35	14.0	15.8	17.5	11.2	12.6	14.0	9.0	10.1	11.2	6.7	7.6	8.4	5.6	6.3	7.0
40	16.0	18.0	20.0	12.8	14.4	16.0	10.2	11.5	12.8	7.7	8.6	9.6	6.4	7.2	8.0
45	18.0	20.3	22.5	14.4	16.2	18.0	11.5	13.0	14.4	8.6	9.7	10.8	7.2	8.1	9.0
50	20.0	22.5	25.0	16.0	18.0	20.0	12.8	14.4	16.0	9.6	10.8	12.0	8.0	9.0	10.0
55	22.0	24.8	27.5	17.6	19.8	22.0	14.1	15.8	17.6	10.6	11.9	13.2	8.8	9.9	11.0
60	24.0	27.0	30.0	19.2	21.6	24.0	15.4	17.3	19.2	11.5	13.0	14.4	9.6	10.8	12.0
65	26.0	29.3	32.5	20.8	23.4	26.0	16.6	18.7	20.8	12.5	14.0	15.6	10.4	11.7	13.0
70	28.0	31.5	35.0	22.4	25.2	28.0	17.9	20.2	22.4	13.4	15.1	16.8	11.2	12.6	14.0
75	30.0	33.8	37.5	24.0	27.0	30.0	19.2	21.6	24.0	14.4	16.2	18.0	12.0	13.5	15.0
80	32.0	36.0	40.0	25.6	28.8	32.0	20.5	23.0	25.6	15.4	17.3	19.2	12.8	14.4	16.0
85	34.0	38.3	42.5	27.2	30.6	34.0	21.8	24.5	27.2	16.3	18.4	20.4	13.6	15.3	17.0
90	36.0	40.5	45.0	28.8	32.4	36.0	23.0	25.9	28.8	17.3	19.4	21.6	14.4	16.2	18.0
100	40.0	45.0	50.0	32.0	36.0	40.0	25.6	28.8	32.0	19.2	21.6	24.0	16.0	18.0	20.0
125	50.0	56.3	62.5	40.0	45.0	50.0	32.0	36.0	40.0	24.0	27.0	30.0	20.0	22.5	25.0
150	60.0	67.5	75.0	48.0	54.0	60.0	38.4	43.2	48.0	28.8	32.4	36.0	24.0	27.0	30.0
175	70.0	78.8	87.5	56.0	63.0	70.0	44.8	50.4	56.0	33.6	37.8	42.0	28.0	31.5	35.0
200	80.0	90.0	100.0	64.0	72.0	80.0	51.2	57.6	64.0	38.4	43.2	48.0	32.0	36.0	40.0
250	100.0	112.5	125.0	80.0	90.0	100.0	64.0	72.0	80.0	48.0	54.0	60.0	40.0	45.0	50.0
300	120.0	135.0	150.0	96.0	108.0	120.0	76.8	86.4	96.0	57.6	64.8	72.0	48.0	54.0	60.0

JIS Extra-Light Load Springs

Rectangular Wire Construction

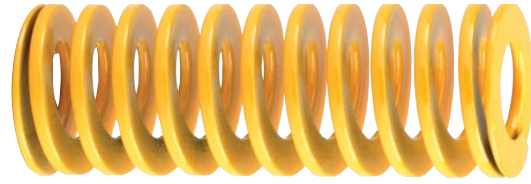
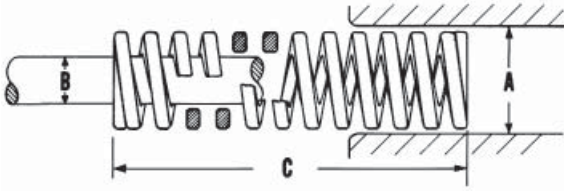

* Note: 1 daN = 1.0197 Kg (Force)

Outer Diam. (mm) A	Inner Diam. (mm) B	Wire Size (mm)	Free Length (mm) C	Catalog Number	Spring *Rate kgf/mm	LOAD-DEFLECTION TABLE					
						0.3 million		0.5 million		1 million	
						Deflection mm	Load kgf (N)	Deflection mm	Load kgf (N)	Deflection mm	Load kgf (N)
10	5	2.1 x 0.8	20	91-1020	1.00	10.0	10 (98.1)	9.0	9 (88.3)	8.0	8 (78.5)
			25	91-1025	0.80	12.5		11.2		10.0	
			30	91-1030	0.67	15.0		13.5		12.0	
			35	91-1035	0.57	17.5		15.7		14.0	
			40	91-1040	0.50	20.0		18.0		16.0	
			45	91-1045	0.44	22.5		20.2		18.0	
			50	91-1050	0.40	25.0		22.5		20.0	
			55	91-1055	0.36	27.5		24.7		22.0	
			60	91-1060	0.33	30.0		27.0		24.0	
			65	91-1065	0.31	32.5		29.2		26.0	
			70	91-1070	0.29	35.0		31.5		28.0	
			75	91-1075	0.27	37.5		33.7		30.0	
12	6	2.5 x 1.2	20	91-1220	1.40	10.0	14 (137.3)	9.0	12.5 (122.6)	8.0	11 (107.9)
			25	91-1225	1.12	12.5		11.2		10.0	
			30	91-1230	0.93	15.0		13.5		12.0	
			35	91-1235	0.80	17.5		15.7		14.0	
			40	91-1240	0.70	20.0		18.0		16.0	
			45	91-1245	0.62	22.5		20.2		18.0	
			50	91-1250	0.56	25.0		22.5		20.0	
			55	91-1255	0.51	27.5		24.7		22.0	
			60	91-1260	0.47	30.0		27.0		24.0	
			65	91-1265	0.43	32.5		29.2		26.0	
			70	91-1270	0.40	35.0		31.5		28.0	
			75	91-1275	0.37	37.5		33.7		30.0	
14	7	3.1 x 1.2	25	91-1425	1.44	12.5	18 (176.5)	11.2	16 (156.9)	10.0	14.5 (142.2)
			30	91-1430	1.20	15.0		13.5		12.0	
			35	91-1435	1.03	17.5		15.7		14.0	
			40	91-1440	0.90	20.0		18.0		16.0	
			45	91-1445	0.80	22.5		20.2		18.0	
			50	91-1450	0.72	25.0		22.5		20.0	
			55	91-1455	0.65	27.5		24.7		22.0	
			60	91-1460	0.60	30.0		27.0		24.0	
			65	91-1465	0.55	32.5		29.2		26.0	
			70	91-1470	0.51	35.0		31.5		28.0	
			75	91-1475	0.48	37.5		33.7		30.0	
			80	91-1480	0.45	40.0		36.0		32.0	
16	8	3.5 x 1.4	25	91-1625	1.68	12.5	21 (206)	11.2	19 (186.3)	10.0	17 (166.7)
			30	91-1630	1.40	15.0		13.5		12.0	
			35	91-1635	1.20	17.5		15.7		14.0	
			40	91-1640	1.05	20.0		18.0		16.0	
			45	91-1645	0.94	22.5		20.0		18.0	
			50	91-1650	0.84	25.0		22.5		20.0	
			55	91-1655	0.77	27.5		24.7		22.0	
			60	91-1660	0.70	30.0		27.0		24.0	
			65	91-1665	0.65	32.5		29.2		26.0	
			70	91-1670	0.60	35.0		31.5		28.0	
			75	91-1675	0.56	37.5		33.7		30.0	
			80	91-1680	0.53	40.0		36.0		32.0	
			90	91-1690	0.47	45.0		40.5	36.0		
			100	91-16100	0.42	50.0		45.0	40.0		

JIS Extra-Light Load Springs

* Note: 1 daN = 1.0197 Kg (Force)

Outer Diam. (mm) A	Inner Diam. (mm) B	Wire Size (mm)	Free Length (mm) C	Catalog Number	Spring *Rate kgf/mm	LOAD-DEFLECTION TABLE					
						0.3 million		0.5 million		1 million	
						Deflection mm	Load kgf (N)	Deflection mm	Load kgf (N)	Deflection mm	Load kgf (N)
18	9	3.9 x 1.5	25	91-1825	2.08	12.5	26 (255)	11.2	23 (226)	10.0	21 (206)
			30	91-1830	1.74	15.0		13.5		12.0	
			35	91-1835	1.49	17.5		15.7		14.0	
			40	91-1840	1.30	20.0		18.0		16.0	
			45	91-1845	1.16	22.5		20.2		18.0	
			50	91-1850	1.04	25.0		22.5		20.0	
			55	91-1855	0.95	27.5		24.7		22.0	
			60	91-1860	0.87	30.0		27.0		24.0	
			65	91-1865	0.80	32.5		29.2		26.0	
			70	91-1870	0.74	35.0		31.5		28.0	
			75	91-1875	0.70	37.5		33.7		30.0	
			80	91-1880	0.65	40.0		36.0		32.0	
90	91-1890	0.58	45.0	40.5	36.0						
100	91-18100	0.52	50.0	45.0	40.0						
20	11	4.0 x 1.7	25	91-2025	2.56	12.5	32 (313.8)	11.2	29 (284.4)	10.0	26 (255.0)
			30	91-2030	2.13	15.0		13.5		12.0	
			35	91-2035	1.83	17.5		15.7		14.0	
			40	91-2040	1.60	20.0		18.0		16.0	
			45	91-2045	1.42	22.5		20.2		18.0	
			50	91-2050	1.28	25.0		22.5		20.0	
			55	91-2055	1.16	27.5		24.7		22.0	
			60	91-2060	1.07	30.0		27.0		24.0	
			65	91-2065	0.98	32.5		29.2		26.0	
			70	91-2070	0.91	35.0		31.5		28.0	
			75	91-2075	0.85	37.5		33.7		30.0	
			80	91-2080	0.80	40.0		36.0		32.0	
			90	91-2090	0.71	45.0		40.5		36.0	
			100	91-20100	0.64	50.0		45.0		40.0	
			125	91-20125	0.51	62.5		56.2		50.0	
150	91-20150	0.43	75.0	67.5	60.0						
22	11	4.7 x 1.9	25	91-2225	3.20	12.5	40 (392)	11.2	36 (353)	10.0	32 (314)
			30	91-2230	2.67	15.0		13.5		12.0	
			35	91-2235	2.29	17.5		15.7		14.0	
			40	91-2240	2.00	20.0		18.0		16.0	
			45	91-2245	1.78	22.5		20.2		18.0	
			50	91-2250	1.60	25.0		22.5		20.0	
			55	91-2255	1.46	27.5		24.7		22.0	
			60	91-2260	1.33	30.0		27.0		24.0	
			65	91-2265	1.23	32.5		29.2		26.0	
			70	91-2270	1.14	35.0		31.5		28.0	
			75	91-2275	1.07	37.5		33.7		30.0	
			80	91-2280	1.00	40.0		36.0		32.0	
			90	91-2290	0.89	45.0		40.5		36.0	
			100	91-22100	0.8	50.0		45.0		40.0	
			125	91-22125	0.64	62.5		56.2		50.0	
150	91-22150	0.53	75.0	67.5	60.0						

JIS Extra-Light Load Springs

Rectangular Wire Construction

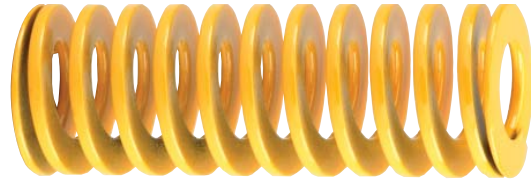
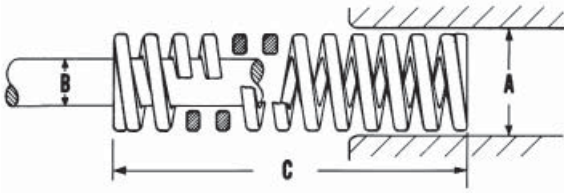

* Note: 1 daN = 1.0197 Kg (Force)

Outer Diam. (mm) A	Inner Diam. (mm) B	Wire Size (mm)	Free Length (mm) C	Catalog Number	Spring *Rate kgf/mm	LOAD-DEFLECTION TABLE					
						0.3 million		0.5 million		1 million	
						Deflection mm	Load kgf (N)	Deflection mm	Load kgf (N)	Deflection mm	Load kgf (N)
25	13.5	5.6 x 2.2	25	91-2525	4.00	12.5	50 (490.3)	11.2	45 (441.3)	10.0	40 (392.3)
			30	91-2530	3.33	15.0		13.5		12.0	
			35	91-2535	2.85	17.5		15.7		14.0	
			40	91-2540	2.50	20.0		18.0		16.0	
			45	91-2545	2.22	22.5		20.2		18.0	
			50	91-2550	2.00	25.0		22.5		20.0	
			55	91-2555	1.82	27.5		24.7		22.0	
			60	91-2560	1.67	30.0		27.0		24.0	
			65	91-2565	1.54	32.5		29.2		26.0	
			70	91-2570	1.43	35.0		31.5		28.0	
			75	91-2575	1.33	37.5		33.7		30.0	
			80	91-2580	1.25	40.0		36.0		32.0	
			90	91-2590	1.11	45.0		40.5		36.0	
			100	91-25100	1.00	50.0		45.0		40.0	
			125	91-25125	0.80	62.5		56.2		50.0	
			150	91-25150	0.67	75.0		67.5		60.0	
			175	91-25175	0.57	87.5		78.7		70.0	
27	13.5	6.4 x 2.2	25	91-2725	4.80	12.5	60 (588)	11.2	54 (530)	10.0	48 (471)
			30	91-2730	4.00	15.0		13.5		12.0	
			35	91-2735	3.43	17.5		15.7		14.0	
			40	91-2740	3.00	20.0		18.0		16.0	
			45	91-2745	2.67	22.5		20.2		18.0	
			50	91-2750	2.40	25.0		22.5		20.0	
			55	91-2755	2.18	27.5		24.7		22.0	
			60	91-2760	2.00	30.0		27.0		24.0	
			65	91-2765	1.85	32.5		29.2		26.0	
			70	91-2770	1.71	35.0		31.5		28.0	
			75	91-2775	1.60	37.5		33.7		30.0	
			80	91-2780	1.50	40.0		36.0		32.0	
			90	91-2790	1.33	45.0		40.5		36.0	
			100	91-27100	1.20	50.0		45.0		40.0	
			125	91-27125	0.96	62.5		56.2		50.0	
			150	91-27150	0.80	75.0		67.5		60.0	
			175	91-27175	0.69	87.5		78.7		70.0	
30	16	6.0 x 2.7	25	91-3025	5.80	12.5	72 (706.1)	11.2	65 (637.4)	10.0	58 (568.8)
			30	91-3030	4.80	15.0		13.5		12.0	
			35	91-3035	4.13	17.5		15.7		14.0	
			40	91-3040	3.60	20.0		18.0		16.0	
			45	91-3045	3.21	22.5		20.2		18.0	
			50	91-3050	2.88	25.0		22.5		20.0	
			55	91-3055	2.63	27.5		24.7		22.0	
			60	91-3060	2.40	30.0		27.0		24.0	
			65	91-3065	2.22	32.5		29.2		26.0	
			70	91-3070	2.05	35.0		31.5		28.0	
			75	91-3075	1.93	37.5		33.7		30.0	
			80	91-3080	1.80	40.0		36.0		32.0	
			90	91-3090	1.60	45.0		40.5		36.0	
			100	91-30100	1.44	50.0		45.0		40.0	
			125	91-30125	1.15	62.5		56.2		50.0	
			150	91-30150	0.96	75.0		67.5		60.0	
			175	91-30175	0.82	87.5		78.7		70.0	
200	91-30200	0.72	100.0	90.0	80.0						

JIS Extra-Light Load Springs

* Note: 1 daN = 1.0197 Kg (Force)

Outer Diam. (mm) A	Inner Diam. (mm) B	Wire Size (mm)	Free Length (mm) C	Catalog Number	Spring *Rate kgf/mm 1 mm	LOAD-DEFLECTION TABLE											
						0.3 million		0.5 million		1 million							
						Deflection mm	Load kgf (N)	Deflection mm	Load kgf (N)	Deflection mm	Load kgf (N)						
35	19	7.4 x 2.8	40	91-3540	4.90	20.0	98 (961.1)	18.0	88 (863.0)	16.0	78 (764.9)						
			45	91-3545	4.36	22.5		20.2		18.0							
			50	91-3550	3.92	25.0		22.5		20.0							
			55	91-3555	3.56	27.5		24.7		22.0							
			60	91-3560	3.26	30.0		27.0		24.0							
			65	91-3565	3.02	32.5		29.2		26.0							
			70	91-3570	2.80	35.0		31.5		28.0							
			75	91-3575	2.61	37.5		33.7		30.0							
			80	91-3580	2.45	40.0		36.0		32.0							
			90	91-3590	2.17	45.0		40.5		36.0							
			100	91-35100	1.96	50.0		45.0		40.0							
			125	91-35125	1.57	62.5		56.2		50.0							
			150	91-35150	1.30	75.0		67.5		60.0							
			175	91-35175	1.12	87.5		78.7		70.0							
200	91-35200	0.98	100.0	90.0	80.0												
40	22	8.5 x 3.2	40	91-4040	6.38	20.0	128 (1255.3)	18.0	115 (1127.8)	16.0	102 (1000.3)						
			50	91-4050	5.12	25.0		22.5		18.0							
			60	91-4060	4.26	30.0		27.0		20.0							
			70	91-4070	3.65	35.0		31.5		22.0							
			80	91-4080	3.20	40.0		36.0		24.0							
			90	91-4090	2.84	45.0		40.5		26.0							
			100	91-40100	2.56	50.0		45.0		28.0							
			125	91-40125	2.04	62.5		56.2		30.0							
			150	91-40150	1.70	75.0		67.5		32.0							
			175	91-40175	1.46	87.5		78.7		36.0							
			200	91-40200	1.28	100.0		90.0		40.0							
			250	91-40250	1.02	125.0		112.5		50.0							
			50	27.5	10.6 x 4.0	50		91-5050		8.00		25.0	200 (1961.3)	22.5	180 (1765.2)	20.0	160 (1569.1)
						60		91-5060		6.66		30.0		27.0		24.0	
70	91-5070	5.71				35.0	31.5	28.0									
80	91-5080	5.00				40.0	36.0	32.0									
90	91-5090	4.44				45.0	40.5	36.0									
100	91-50100	4.00				50.0	45.0	40.0									
125	91-50125	3.20				62.5	56.2	50.0									
150	91-50150	2.66				75.0	67.5	60.0									
175	91-50175	2.28				87.5	78.7	70.0									
200	91-50200	2.00				100.0	90.0	80.0									
250	91-50250	1.60				125.0	112.5	100.0									
300	91-50300	1.33				150.0	135.0	120.0									
60	33	13.0 x 4.8				60	91-6060	9.59	30.0	288 (2824.3)	27.0	259 (2539.9)		24.0		230 (2255.5)	
						70	91-6070	8.22	35.0		31.5			28.0			
			80	91-6080	7.19	40.0	36.0	32.0									
			90	91-6090	6.40	45.0	40.5	36.0									
			100	91-60100	5.76	50.0	45.0	40.0									
			125	91-60125	4.60	62.5	56.2	50.0									
			150	91-60150	3.84	75.0	67.5	60.0									
			175	91-60175	3.29	87.5	78.7	70.0									
			200	91-60200	2.88	100.0	90.0	80.0									
			250	91-60250	2.30	125.0	112.5	100.0									
300	91-60300	1.92	150.0	135.0	120.0												

JIS Light Load Springs

Rectangular Wire Construction

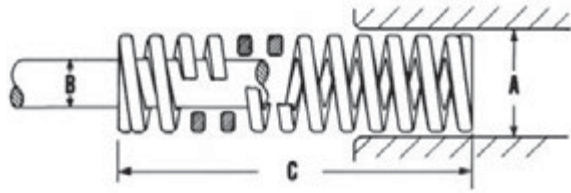

* Note: 1 daN = 1.0197 Kg (Force)

Outer Diam. (mm) A	Inner Diam. (mm) B	Wire Size (mm)	Free Length (mm) C	Catalog Number	Spring *Rate kgf/mm	LOAD-DEFLECTION TABLE					
						0.3 million		0.5 million		1 million	
						Deflection mm	Load kgf (N)	Deflection mm	Load kgf (N)	Deflection mm	Load kgf (N)
10	5	2.0 x 1.0	20	92-1020	1.81	8.0	14.5 (142.2)	7.2	13 (127.5)	6.4	11.5 (112.8)
			25	92-1025	1.45	10.0		9.0		8.0	
			30	92-1030	1.21	12.0		10.8		9.6	
			35	92-1035	1.03	14.0		12.6		11.2	
			40	92-1040	0.90	16.0		14.4		12.8	
			45	92-1045	0.80	18.0		16.2		14.4	
			50	92-1050	0.73	20.0		18.0		16.0	
			55	92-1055	0.66	22.0		19.8		17.6	
			60	92-1060	0.60	24.0		21.6		19.2	
			65	92-1065	0.55	26.0		23.4		20.8	
			70	92-1070	0.51	28.0		25.2		22.4	
			75	92-1075	0.48	30.0		27.0		24.0	
			80	92-1080	0.45	32.0	28.8	25.6			
			20	92-1220	2.63	8.0	7.2	6.4			
			25	92-1225	2.10	10.0	9.0	8.0			
			30	92-1230	1.75	12.0	10.8	9.6			
			35	92-1235	1.50	14.0	12.6	11.2			
			40	92-1240	1.32	16.0	14.4	12.8			
			45	92-1245	1.17	18.0	16.2	14.4			
			50	92-1250	1.05	20.0	18.0	16.0			
			55	92-1255	0.96	22.0	19.8	17.6			
			60	92-1260	0.88	24.0	21.6	19.2			
			65	92-1265	0.81	26.0	23.4	20.8			
			70	92-1270	0.75	28.0	25.2	22.4			
			75	92-1275	0.70	30.0	27.0	24.0			
			80	92-1280	0.66	32.0	28.8	25.6			
			25	92-1425	2.80	10.0	9.0	8.0			
			30	92-1430	2.34	12.0	10.8	9.6			
			35	92-1435	2.00	14.0	12.6	11.2			
			40	92-1440	1.75	16.0	14.4	12.8			
			45	92-1445	1.56	18.0	16.2	14.4			
			50	92-1450	1.40	20.0	18.0	16.0			
			55	92-1455	1.27	22.0	19.8	17.6			
			60	92-1460	1.17	24.0	21.6	19.2			
			65	92-1465	1.08	26.0	23.4	20.8			
			70	92-1470	1.00	28.0	25.2	22.4			
			75	92-1475	0.93	30.0	27.0	24.0			
			80	92-1480	0.87	32.0	28.8	25.6			
			90	92-1490	0.77	36.0	32.4	28.8			
			25	92-1625	3.50	10.0	9.0	8.0			
			30	92-1630	2.92	12.0	10.8	9.6			
			35	92-1635	2.50	14.0	12.6	11.2			
			40	92-1640	2.19	16.0	14.4	12.8			
			45	92-1645	1.95	18.0	16.2	14.4			
			50	92-1650	1.75	20.0	18.0	16.0			
			55	92-1655	1.60	22.0	19.8	17.6			
			60	92-1660	1.46	24.0	21.6	19.2			
			65	92-1665	1.35	26.0	23.4	20.8			
			70	92-1670	1.25	28.0	25.2	22.4			
			75	92-1675	1.17	30.0	27.0	24.0			
			80	92-1680	1.10	32.0	28.8	25.6			
			90	92-1690	0.98	36.0	32.4	28.8			
			100	92-16100	0.88	40.0	36.0	32.0			

JIS Light Load Springs

* Note: 1 daN = 1.0197 Kg (Force)

Outer Diam. (mm) A	Inner Diam. (mm) B	Wire Size (mm)	Free Length (mm) C	Catalog Number	Spring *Rate kgf/mm	LOAD-DEFLECTION TABLE					
						0.3 million		0.5 million		1 million	
						Deflection mm	Load kgf (N)	Deflection mm	Load kgf (N)	Deflection mm	Load kgf (N)
18	9	4.0 x 1.8	25	92-1825	4.30	10.0	43 (422)	9.0	39 (382)	8.0	34 (333)
			30	92-1830	3.58	12.0		10.8		9.6	
			35	92-1835	3.07	14.0		12.6		11.2	
			40	92-1840	2.69	16.0		14.4		12.8	
			45	92-1845	2.39	18.0		16.2		14.4	
			50	92-1850	2.15	20.0		18.0		16.0	
			55	92-1855	1.96	22.0		19.8		17.6	
			60	92-1860	1.79	24.0		21.6		19.2	
			65	92-1865	1.66	26.0		23.4		20.8	
			70	92-1870	1.54	28.0		25.2		22.4	
			75	92-1875	1.44	30.0		27.0		24.0	
			80	92-1880	1.35	32.0		28.8		25.6	
			90	92-1890	1.20	36.0		32.4		28.8	
100	92-18100	1.07	40.0	36.0	32.0						
20	10	4.5 x 2.0	25	92-2025	5.40	10.0	54 (529.6)	9.0	49 (481)	8.0	43 (421.7)
			30	92-2030	4.50	12.0		10.8		9.6	
			35	92-2035	3.86	14.0		12.6		11.2	
			40	92-2040	3.38	16.0		14.4		12.8	
			45	92-2045	3.00	18.0		16.2		14.4	
			50	92-2050	2.70	20.0		18.0		16.0	
			55	92-2055	2.45	22.0		19.8		17.6	
			60	92-2060	2.25	24.0		21.6		19.2	
			65	92-2065	2.08	26.0		23.4		20.8	
			70	92-2070	1.93	28.0		25.2		22.4	
			75	92-2075	1.80	30.0		27.0		24.0	
			80	92-2080	1.69	32.0		28.8		25.6	
			90	92-2090	1.50	36.0		32.4		28.8	
100	92-20100	1.35	40.0	36.0	32.0						
125	92-20125	1.08	50.0	45.0	40.0						
150	92-20150	0.90	60.0	54.0	48.0						
22	11	4.9 x 2.2	25	92-2225	6.70	10.0	67 (657)	9.0	60 (588)	8.0	54 (530)
			30	92-2230	5.60	12.0		10.8		9.6	
			35	92-2235	4.80	14.0		12.6		11.2	
			40	92-2240	4.20	16.0		14.4		12.8	
			45	92-2245	3.72	18.0		16.2		14.4	
			50	92-2250	3.35	20.0		18.0		16.0	
			55	92-2255	3.05	22.0		19.8		17.6	
			60	92-2260	2.80	24.0		21.6		19.2	
			65	92-2265	2.58	26.0		23.4		20.8	
			70	92-2270	2.40	28.0		25.2		22.4	
			75	92-2275	2.23	30.0		27.0		24.0	
			80	92-2280	2.10	32.0		28.8		25.6	
			90	92-2290	1.86	36.0		32.4		28.8	
100	92-22100	1.68	40.0	36.0	32.0						
125	92-22125	1.34	50.0	45.0	40.0						
150	92-22150	1.12	60.0	54.0	48.0						

JIS Light Load Springs

Rectangular Wire Construction

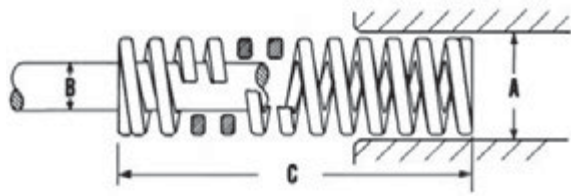

* Note: 1 daN = 1.0197 Kg (Force)

Outer Diam. (mm) A	Inner Diam. (mm) B	Wire Size (mm)	Free Length (mm) C	Catalog Number	Spring *Rate kgf/mm	LOAD-DEFLECTION TABLE					
						0.3 million		0.5 million		1 million	
						Deflection mm	Load kgf (N)	Deflection mm	Load kgf (N)	Deflection mm	Load kgf (N)
25	12.5	5.7 x 2.5	25	92-2525	8.40	10.0	84 (823.8)	9.0	76 (745)	8.0	67 (657.1)
			30	92-2530	7.00	12.0		10.8		9.6	
			35	92-2535	6.00	14.0		12.6		11.2	
			40	92-2540	5.25	16.0		14.4		12.8	
			45	92-2545	4.67	18.0		16.2		14.4	
			50	92-2550	4.20	20.0		18.0		16.0	
			55	92-2555	3.82	22.0		19.8		17.6	
			60	92-2560	3.50	24.0		21.6		19.2	
			65	92-2565	3.23	26.0		23.4		20.8	
			70	92-2570	3.00	28.0		25.2		22.4	
			75	92-2575	2.80	30.0		27.0		24.0	
			80	92-2580	2.63	32.0		28.8		25.6	
			90	92-2590	2.33	36.0		32.4		28.8	
			100	92-25100	2.10	40.0		36.0		32.0	
			125	92-25125	1.68	50.0		45.0		40.0	
150	92-25150	1.40	60.0	54.0	48.0						
175	92-25175	1.20	70.0	63.0	56.0						
27	13.5	6.3 x 2.7	25	92-2725	10.00	10.0	100 (981)	9.0	90 (883)	8.0	80 (785)
			30	92-2730	8.33	12.0		10.8		9.6	
			35	92-2735	7.14	14.0		12.6		11.2	
			40	92-2740	6.25	16.0		14.4		12.8	
			45	92-2745	5.56	18.0		16.2		14.4	
			50	92-2750	5.00	20.0		18.0		16.0	
			55	92-2755	4.55	22.0		19.8		17.6	
			60	92-2760	4.17	24.0		21.6		19.2	
			65	92-2765	3.85	26.0		23.4		20.8	
			70	92-2770	3.57	28.0		25.2		22.4	
			75	92-2775	3.33	30.0		27.0		24.0	
			80	92-2780	3.13	32.0		28.8		25.6	
			90	92-2790	2.78	36.0		32.4		28.8	
			100	92-27100	2.50	40.0		36.0		32.0	
			125	92-27125	2.00	50.0		45.0		40.0	
150	92-27150	1.67	60.0	54.0	48.0						
175	92-27175	1.43	70.0	63.0	56.0						
30	15	6.8 x 3.0	25	92-3025	12.11	10.0	121 (1186.6)	9.0	109 (1068.9)	8.0	97 (951.3)
			30	92-3030	10.08	12.0		10.8		9.6	
			35	92-3035	8.65	14.0		12.6		11.2	
			40	92-3040	7.56	16.0		14.4		12.8	
			45	92-3045	6.73	18.0		16.2		14.4	
			50	92-3050	6.05	20.0		18.0		16.0	
			55	92-3055	5.50	22.0		19.8		17.6	
			60	92-3060	5.04	24.0		21.6		19.2	
			65	92-3065	4.65	26.0		23.4		20.8	
			70	92-3070	4.32	28.0		25.2		22.4	
			75	92-3075	4.03	30.0		27.0		24.0	
			80	92-3080	3.78	32.0		28.8		25.6	
			90	92-3090	3.36	36.0		32.4		28.8	
			100	92-30100	3.02	40.0		36.0		32.0	
			125	92-30125	2.42	50.0		45.0		40.0	
150	92-30150	2.01	60.0	54.0	48.0						
175	92-30175	1.72	70.0	63.0	56.0						
200	92-30200	1.51	80.0	72.0	64.0						

JIS Light Load Springs

* Note: 1 daN = 1.0197 Kg (Force)

Outer Diam. (mm) A	Inner Diam. (mm) B	Wire Size (mm)	Free Length (mm) C	Catalog Number	Spring *Rate kgf/mm	LOAD-DEFLECTION TABLE											
						0.3 million		0.5 million		1 million							
						Deflection mm	Load kgf (N)	Deflection mm	Load kgf (N)	Deflection mm	Load kgf (N)						
35	17.5	8.2 x 3.2	40	92-3540	10.31	16.0	165 (1618.1)	14.4	149 (1461.2)	12.8	132 (1294.5)						
			45	92-3545	9.17	18.0		16.2		14.4							
			50	92-3550	8.25	20.0		18.0		16.0							
			55	92-3555	7.50	22.0		19.8		17.6							
			60	92-3560	6.87	24.0		21.6		19.2							
			65	92-3565	6.35	26.0		23.4		20.8							
			70	92-3570	5.89	28.0		25.2		22.4							
			75	92-3575	5.50	30.0		27.0		24.0							
			80	92-3580	5.15	32.0		28.8		25.6							
			90	92-3590	4.58	36.0		32.4		28.8							
			100	92-35100	4.12	40.0		36.0		32.0							
			125	92-35125	3.30	50.0		45.0		40.0							
			150	92-35150	2.75	60.0		54.0		48.0							
			175	92-35175	2.35	70.0		63.0		56.0							
200	92-35200	2.06	80.0	72.0	64.0												
40	20	9.5 x 3.8	40	92-4040	13.50	16.0	216 (2118.2)	14.4	194 (1902.5)	12.8	173 (1696.6)						
			50	92-4050	10.80	20.0		18.0		16.0							
			60	92-4060	9.00	24.0		21.6		19.2							
			70	92-4070	7.71	28.0		25.2		22.4							
			80	92-4080	6.75	32.0		28.8		25.6							
			90	92-4090	6.00	36.0		32.4		28.8							
			100	92-40100	5.40	40.0		36.0		32.0							
			125	92-40125	4.32	50.0		45.0		40.0							
			150	92-40150	3.60	60.0		54.0		48.0							
			175	92-40175	3.08	70.0		63.0		56.0							
			200	92-40200	2.70	80.0		72.0		64.0							
			250	92-40250	2.16	100.0		90.0		80.0							
			50	25	12.1 x 4.8	50		92-5050		16.89		20.0	338 (3314.7)	18.0	304 (2981.2)	16.0	270 (2647.8)
						60		92-5060		14.08		24.0		21.6		19.2	
70	92-5070	12.07				28.0	25.2	22.4									
80	92-5080	10.56				32.0	28.8	25.6									
90	92-5090	9.38				36.0	32.4	28.8									
100	92-50100	8.45				40.0	36.0	32.0									
125	92-50125	6.76				50.0	45.0	40.0									
150	92-50150	5.63				60.0	54.0	48.0									
175	92-50175	4.82				70.0	63.0	56.0									
200	92-50200	4.22				80.0	72.0	64.0									
250	92-50250	3.38				100.0	90.0	80.0									
300	92-50300	2.81				120.0	108.0	96.0									
60	30	14.4 x 5.7				60	92-6060	20.25	24.0	486 (4766.0)	21.6	437 (4285.5)		19.2		389 (3814.8)	
						70	92-6070	17.35	28.0		25.2			22.4			
			80	92-6080	15.18	32.0	28.8	25.6									
			90	92-6090	13.50	36.0	32.4	28.8									
			100	92-60100	12.15	40.0	36.0	32.0									
			125	92-60125	9.72	50.0	45.0	40.0									
			150	92-60150	8.10	60.0	54.0	48.0									
			175	92-60175	6.94	70.0	63.0	56.0									
			200	92-60200	6.07	80.0	72.0	64.0									
			250	92-60250	4.86	100.0	90.0	80.0									
300	92-60300	4.05	120.0	108.0	96.0												

JIS Medium Load Springs

Rectangular Wire Construction

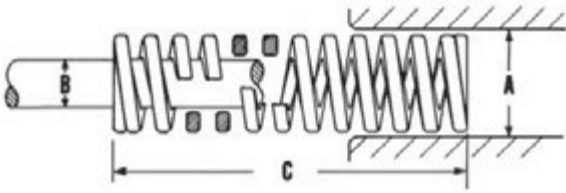

* Note: 1 daN = 1.0197 Kg (Force)

Outer Diam. (mm) A	Inner Diam. (mm) B	Wire Size (mm)	Free Length (mm) C	Catalog Number	Spring *Rate kgf/mm 1 mm	LOAD-DEFLECTION TABLE					
						0.3 million		0.5 million		1 million	
						Deflection mm	Load kgf (N)	Deflection mm	Load kgf (N)	Deflection mm	Load kgf (N)
10	5	2.0 x 1.4	20	93-1020	3.13	6.4	20 (196.1)	5.8	18 (176.5)	5.1	16 (156.9)
			25	93-1025	2.50	8.0		7.2		6.4	
			30	93-1030	2.08	9.6		8.6		7.7	
			35	93-1035	1.78	11.2		10.1		9.0	
			40	93-1040	1.56	12.8		11.5		10.2	
			45	93-1045	1.38	14.4		13.0		11.5	
			50	93-1050	1.25	16.0		14.4		12.8	
			55	93-1055	1.13	17.6		15.8		14.1	
			60	93-1060	1.04	19.2		17.3		15.4	
			65	93-1065	0.96	20.8		18.7		16.6	
			70	93-1070	0.89	22.4		20.2		17.9	
			75	93-1075	0.83	24.0		21.6		19.2	
			80	93-1080	0.78	25.6	23.0	20.5			
			20	93-1220	4.53	6.4	29 (284.4)	5.8	26 (255.0)	5.1	23 (225.6)
			25	93-1225	3.62	8.0		7.2		6.4	
			30	93-1230	3.02	9.6		8.6		7.7	
			35	93-1235	2.58	11.2		10.1		9.0	
			40	93-1240	2.27	12.8		11.5		10.2	
			45	93-1245	2.01	14.4		13.0		11.5	
			50	93-1250	1.81	16.0		14.4		12.8	
			55	93-1255	1.64	17.6		15.8		14.1	
			60	93-1260	1.51	19.2		17.3		15.4	
			65	93-1265	1.39	20.8		18.7		16.6	
			70	93-1270	1.29	22.4		20.2		17.9	
75	93-1270	1.20	24.0	21.6	19.2						
			80	93-1280	1.13	25.6	23.0	20.5			
			25	93-1425	4.87	8.0	39 (382.5)	7.2	35 (343.2)	6.4	31 (304.0)
			30	93-1430	4.06	9.6		8.6		7.7	
			35	93-1435	3.48	11.2		10.1		9.0	
			40	93-1440	3.04	12.8		11.5		10.2	
			45	93-1445	2.70	14.4		13.0		11.5	
			50	93-1450	2.43	16.0		14.4		12.8	
			55	93-1455	2.21	17.6		15.8		14.1	
			60	93-1460	2.03	19.2		17.3		15.4	
			65	93-1465	1.87	20.8		18.7		16.6	
			70	93-1470	1.74	22.4		20.2		17.9	
			75	93-1475	1.62	24.0		21.6		19.2	
80	93-1480	1.52	25.6	23.0	20.5						
			90	93-1490	1.35	28.8	25.9	23.0			
			25	93-1625	6.39	8.0	51 (500.1)	7.2	46 (451.1)	6.4	41 (402.1)
			30	93-1630	5.32	9.6		8.6		7.7	
			35	93-1635	4.55	11.2		10.1		9.0	
			40	93-1640	3.98	12.8		11.5		10.2	
			45	93-1645	3.54	14.4		13.0		11.5	
			50	93-1650	3.18	16.0		14.4		12.8	
			55	93-1655	2.89	17.6		15.8		14.1	
			60	93-1660	2.65	19.2		17.3		15.4	
			65	93-1665	2.45	20.8		18.7		16.6	
			70	93-1670	2.27	22.4		20.2		17.9	
			75	93-1675	2.11	24.0		21.6		19.2	
80	93-1680	1.99	25.6	23.0	20.5						
			90	93-1690	1.77	28.8	25.9	23.0			
			100	93-16100	1.59	32.0	28.8	25.6			

JIS Medium Load Springs

* Note: 1 daN = 1.0197 Kg (Force)

Outer Diam. (mm) A	Inner Diam. (mm) B	Wire Size (mm)	Free Length (mm) C	Catalog Number	Spring *Rate kgf/mm	LOAD-DEFLECTION TABLE					
						0.3 million		0.5 million		1 million	
						Deflection mm	Load kgf (N)	Deflection mm	Load kgf (N)	Deflection mm	Load kgf (N)
18	9	4.0 x 2.2	25	93-1825	8.12	8.0	65 (637.4)	7.2	58 (568.8)	6.4	52 (510.0)
			30	93-1830	6.77	9.6		8.6		7.7	
			35	93-1835	5.80	11.2		10.1		9.0	
			40	93-1840	5.07	12.8		11.5		10.2	
			45	93-1845	4.51	14.4		13.0		11.5	
			50	93-1850	4.06	16.0		14.4		12.8	
			55	93-1855	3.69	17.6		15.8		14.1	
			60	93-1860	3.38	19.2		17.3		15.4	
			65	93-1865	3.12	20.8		18.7		16.6	
			70	93-1870	2.90	22.4		20.2		17.9	
			75	93-1875	2.70	24.0		21.6		19.2	
			80	93-1880	2.53	25.6		23.0		20.5	
			90	93-1890	2.25	28.8		25.9		23.0	
100	93-18100	2.02	32.0	28.8	25.6						
20	10	4.5 x 2.5	25	93-2025	10.00	8.0	80 (784.5)	7.2	72 (706.1)	6.4	64 (627.6)
			30	93-2030	8.33	9.6		8.6		7.7	
			35	93-2035	7.14	11.2		10.1		9.0	
			40	93-2040	6.25	12.8		11.5		10.2	
			45	93-2045	5.55	14.4		13.0		11.5	
			50	93-2050	5.00	16.0		14.4		12.8	
			55	93-2055	4.54	17.6		15.8		14.1	
			60	93-2060	4.16	19.2		17.3		15.4	
			65	93-2065	3.84	20.8		18.7		16.6	
			70	93-2070	3.57	22.4		20.2		17.9	
			75	93-2075	3.33	24.0		21.6		19.2	
			80	93-2080	3.12	25.6		23.0		20.5	
			90	93-2090	2.77	28.8		25.9		23.0	
100	93-20100	2.50	32.0	28.8	25.6						
125	93-20125	2.00	40.0	36.0	32.0						
150	93-20150	1.67	48.0	43.2	38.4						
22	11	5.0 x 2.8	25	93-2225	12.13	8.0	97 (951.3)	7.2	87 (853.2)	6.4	77 (755.1)
			30	93-2230	10.10	9.6		8.6		7.7	
			35	93-2235	8.65	11.2		10.1		9.0	
			40	93-2240	7.57	12.8		11.5		10.2	
			45	93-2245	6.74	14.4		13.0		11.5	
			50	93-2250	6.06	16.0		14.4		12.8	
			55	93-2255	5.50	17.6		15.8		14.1	
			60	93-2260	5.05	19.2		17.3		15.4	
			65	93-2265	4.66	20.8		18.7		16.6	
			70	93-2270	4.33	22.4		20.2		17.9	
			75	93-2275	4.04	24.0		21.6		19.2	
			80	93-2280	3.78	25.6		23.0		20.5	
			90	93-2290	3.36	28.8		25.9		23.0	
100	93-22100	3.03	32.0	28.8	25.6						
125	93-22125	2.42	40.0	36.0	32.0						
150	93-22150	2.01	48.0	43.2	38.4						

JIS Medium Load Springs

Rectangular Wire Construction

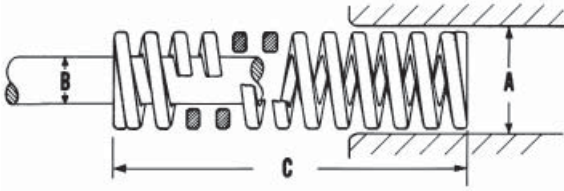

* Note: 1 daN = 1.0197 Kg (Force)

Outer Diam. (mm) A	Inner Diam. (mm) B	Wire Size (mm)	Free Length (mm) C	Catalog Number	Spring *Rate kgf/mm	LOAD-DEFLECTION TABLE					
						0.3 million		0.5 million		1 million	
						Deflection mm	Load kgf (N)	Deflection mm	Load kgf (N)	Deflection mm	Load kgf (N)
25	12.5	5.7 x 3.1	25	93-2525	15.63	8.0	125 (1225.8)	7.2	112 (1098.3)	6.4	100 (980.7)
			30	93-2530	13.02	9.6		8.6		7.7	
			35	93-2535	11.20	11.2		10.1		9.0	
			40	93-2540	9.76	12.8		11.5		10.2	
			45	93-2545	8.68	14.4		13.0		11.5	
			50	93-2550	7.81	16.0		14.4		12.8	
			55	93-2555	7.10	17.6		15.8		14.1	
			60	93-2560	6.51	19.2		17.3		15.4	
			65	93-2565	6.00	20.8		18.7		16.6	
			70	93-2570	5.58	22.4		20.2		17.9	
			75	93-2575	5.21	24.0		21.6		19.2	
			80	93-2580	4.88	25.6		23.0		20.5	
			90	93-2590	4.34	28.8		25.9		23.0	
			100	93-25100	3.90	32.0		28.8		25.6	
			125	93-25125	3.12	40.0		36.0		32.0	
			150	93-25150	2.60	48.0		43.2		38.4	
			175	93-25175	2.23	56.0		50.4		44.8	
27	13.5	6.1 x 3.4	25	93-2725	18.25	8.0	146 (1431.8)	7.2	131 (1284.7)	6.4	117 (1147.4)
			30	93-2730	15.20	9.6		8.6		7.7	
			35	93-2735	13.04	11.2		10.1		9.0	
			40	93-2740	11.40	12.8		11.5		10.2	
			45	93-2745	10.14	14.4		13.0		11.5	
			50	93-2750	9.12	16.0		14.4		12.8	
			55	93-2755	8.30	17.6		15.8		14.1	
			60	93-2760	7.60	19.2		17.3		15.4	
			65	93-2765	7.00	20.8		18.7		16.6	
			70	93-2770	6.51	22.4		20.2		17.9	
			75	93-2775	6.08	24.0		21.6		19.2	
			80	93-2780	5.70	25.6		23.0		20.5	
			90	93-2790	5.06	28.8		25.9		23.0	
			100	93-27100	4.56	32.0		28.8		25.6	
			125	93-27125	3.65	40.0		36.0		32.0	
			150	93-27150	3.04	48.0		43.2		38.4	
			175	93-27175	2.61	56.0		50.4		44.8	
30	15	6.5 x 4.0	25	93-3025	22.50	8.0	180 (1765.2)	7.2	161 (1578.9)	6.4	144 (1412.2)
			30	93-3030	18.75	9.6		8.6		7.7	
			35	93-3035	16.10	11.2		10.1		9.0	
			40	93-3040	14.06	12.8		11.5		10.2	
			45	93-3045	12.50	14.4		13.0		11.5	
			50	93-3050	11.25	16.0		14.4		12.8	
			55	93-3055	10.23	17.6		15.8		14.1	
			60	93-3060	9.37	19.2		17.3		15.4	
			65	93-3065	8.65	20.8		18.7		16.6	
			70	93-3070	8.03	22.4		20.2		17.9	
			75	93-3075	7.50	24.0		21.6		19.2	
			80	93-3080	7.03	25.6		23.0		20.5	
			90	93-3090	6.25	28.8		25.9		23.0	
			100	93-30100	5.62	32.0		28.8		25.6	
			125	93-30125	4.50	40.0		36.0		32.0	
			150	93-30150	3.75	48.0		43.2		38.4	
			175	93-30175	3.21	56.0		50.4		44.8	
200	93-30200	2.81	64.0	57.6	51.2						

JIS Medium Load Springs

* Note: 1 daN = 1.0197 Kg (Force)

Outer Diam. (mm) A	Inner Diam. (mm) B	Wire Size (mm)	Free Length (mm) C	Catalog Number	Spring *Rate kgf/mm	LOAD-DEFLECTION TABLE											
						0.3 million		0.5 million		1 million							
						Deflection mm	Load kgf (N)	Deflection mm	Load kgf (N)	Deflection mm	Load kgf (N)						
35	17.5	7.7 x 4.3	40	93-3540	19.14	12.8	245 (2402.6)	11.5	220 (2157.4)	10.2	195 (1912.3)						
			45	93-3545	17.01	14.4		13.0		11.5							
			50	93-3550	15.31	16.0		14.4		12.8							
			55	93-3555	13.92	17.6		15.8		14.1							
			60	93-3560	12.76	19.2		17.3		15.4							
			65	93-3565	11.77	20.8		18.7		16.6							
			70	93-3570	10.93	22.4		20.2		17.9							
			75	93-3575	10.20	24.0		21.6		19.2							
			80	93-3580	9.57	25.6		23.0		20.5							
			90	93-3590	8.50	28.8		25.9		23.0							
			100	93-35100	7.65	32.0		28.8		25.6							
			125	93-35125	6.12	40.0		36.0		32.0							
			150	93-35125	5.10	48.0		43.2		38.4							
			175	93-35175	4.37	56.0		50.4		44.8							
200	93-35200	3.82	64.0	57.6	51.2												
40	20	9.4 x 4.8	40	93-4040	25.02	12.8	320 (3138.1)	11.5	288 (2824.3)	10.2	256 (2510.4)						
			50	93-4050	20.00	16.0		14.4		12.8							
			60	93-4060	16.60	19.2		17.3		15.4							
			70	93-4070	14.28	22.4		20.2		17.9							
			80	93-4080	12.50	25.6		23.0		20.5							
			90	93-4090	11.11	28.8		25.9		23.0							
			100	93-40100	10.00	32.0		28.8		25.6							
			125	93-40125	8.00	40.0		36.0		32.0							
			150	93-40150	6.66	48.0		43.2		38.4							
			175	93-40175	5.71	56.0		50.4		44.8							
			200	93-40200	5.00	64.0		57.6		51.2							
			250	93-40250	4.00	80.0		72.0		64.0							
			50	25	11.5 x 6.1	50		93-5050		31.25		16.0	500 (4903.3)	14.4	450 (4413.0)	12.8	400 (3922.4)
						60		93-5060		26.04		19.2		17.3		15.4	
70	93-5070	22.32				22.4	20.2	17.9									
80	93-5080	19.53				25.6	23.0	20.5									
90	93-5090	17.36				28.8	25.9	23.0									
100	93-50100	15.62				32.0	28.8	25.6									
125	93-50125	12.50				40.0	36.0	32.0									
150	93-50150	10.41				48.0	43.2	38.4									
175	93-50175	8.92				56.0	50.4	44.8									
200	93-50200	7.81				64.0	57.6	51.2									
250	93-50250	6.25				80.0	72.0	64.0									
300	93-50300	5.20				96.0	86.4	76.8									
60	30	13.6 x 7.6				60	93-6060	37.40	19.2	723 (7060.8)	17.3	648 (6354.7)		15.4		575 (5638.8)	
						70	93-6070	32.10	22.4		20.2			17.9			
			80	93-6080	28.12	25.6	23.0	20.5									
			90	93-6090	25.00	28.8	25.9	23.0									
			100	93-60100	22.50	32.0	28.8	25.6									
			125	93-60125	18.00	40.0	36.0	32.0									
			150	93-60150	15.00	48.0	43.2	38.4									
			175	93-60175	12.85	56.0	50.4	44.8									
			200	93-60200	11.25	64.0	57.6	51.2									
			250	93-60250	9.00	80.0	72.0	64.0									
300	93-60300	7.50	96.0	86.4	76.8												

JIS Heavy Load Springs

Rectangular Wire Construction

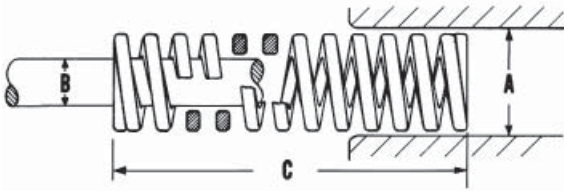

* Note: 1 daN = 1.0197 Kg (Force)

Outer Diam. (mm) A	Inner Diam. (mm) B	Wire Size (mm)	Free Length (mm) C	Catalog Number	Spring *Rate kgf/mm	LOAD-DEFLECTION TABLE					
						0.3 million		0.5 million		1 million	
						Deflection mm	Load kgf (N)	Deflection mm	Load kgf (N)	Deflection mm	Load kgf (N)
10	5	2.0 x 1.7	20	94-1020	6.25	4.8	30 (294.2)	4.3	27 (264.8)	3.8	24 (235.4)
			25	94-1025	5.00	6.0		5.4		4.8	
			30	94-1030	4.16	7.2		6.5		5.8	
			35	94-1035	3.57	8.4		7.5		6.7	
			40	94-1040	3.15	9.6		8.6		7.7	
			45	94-1045	2.77	10.8		9.7		8.6	
			50	94-1050	2.50	12.0		10.8		9.6	
			55	94-1055	2.27	13.2		11.8		10.6	
			60	94-1060	2.08	14.4		13.0		11.5	
			65	94-1065	1.92	15.6		14.0		12.5	
			70	94-1070	1.79	16.8		15.1		13.4	
			75	94-1075	1.67	18.0		16.2		14.4	
			80	94-1080	1.56	19.2		17.3		15.4	
12	6	2.5 x 2.0	20	94-1220	8.90	4.8	43 (421.7)	4.3	38 (372.7)	3.8	34 (333.4)
			25	94-1225	7.10	6.0		5.4		4.8	
			30	94-1230	5.97	7.2		6.5		5.8	
			35	94-1235	5.11	8.4		7.5		6.7	
			40	94-1240	4.47	9.6		8.6		7.7	
			45	94-1245	3.98	10.8		9.7		8.6	
			50	94-1250	3.58	12.0		10.8		9.6	
			55	94-1255	3.25	13.2		11.8		10.6	
			60	94-1260	2.98	14.4		13.0		11.5	
			65	94-1265	2.74	15.6		14.0		12.5	
			70	94-1270	2.54	16.8		15.1		13.4	
			75	94-1275	2.37	18.0		16.2		14.4	
			80	94-1280	2.21	19.2		17.3		15.4	
14	7	3.0 x 2.3	25	94-1425	9.83	6.0	59 (578.6)	5.4	53 (519.8)	4.8	47 (460.9)
			30	94-1430	8.19	7.2		6.5		5.8	
			35	94-1435	7.02	8.4		7.5		6.7	
			40	94-1440	6.14	9.6		8.6		7.7	
			45	94-1445	5.46	10.8		9.7		8.6	
			50	94-1450	4.91	12.0		10.8		9.6	
			55	94-1455	4.46	13.2		11.8		10.6	
			60	94-1460	4.09	14.4		13.0		11.5	
			65	94-1465	3.78	15.6		14.0		12.5	
			70	94-1470	3.51	16.8		15.1		13.4	
			75	94-1475	3.27	18.0		16.2		14.4	
			80	94-1480	3.07	19.2		17.3		15.4	
			90	94-1490	2.72	21.6		19.4		17.3	
16	8	3.5 x 2.5	25	94-1625	18.83	6.0	77 (755)	5.4	69 (676.7)	4.8	62 (608.0)
			30	94-1630	10.69	7.2		6.5		5.8	
			35	94-1635	9.16	8.4		7.5		6.7	
			40	94-1640	8.02	9.6		8.6		7.7	
			45	94-1645	7.12	10.8		9.7		8.6	
			50	94-1650	6.41	12.0		10.8		9.6	
			55	94-1655	5.83	13.2		11.8		10.6	
			60	94-1660	5.34	14.4		13.0		11.5	
			65	94-1665	4.93	15.6		14.0		12.5	
			70	94-1670	4.58	16.8		15.1		13.4	
			75	94-1675	4.28	18.0		16.2		14.4	
			80	94-1680	4.01	19.2		17.3		15.4	
			90	94-1690	3.57	21.6		19.4		17.3	
100	94-16100	3.21	24.0	21.6	19.2						

JIS Heavy Load Springs

* Note: 1 daN = 1.0197 Kg (Force)

Outer Diam. (mm) A	Inner Diam. (mm) B	Wire Size (mm)	Free Length (mm) C	Catalog Number	Spring *Rate kgf/mm	LOAD-DEFLECTION TABLE					
						0.3 million		0.5 million		1 million	
						Deflection mm	Load kgf (N)	Deflection mm	Load kgf (N)	Deflection mm	Load kgf (N)
18	9	4.0 x 2.7	25	94-1825	16.16	6.0	97 (951.3)	5.4	87 (853.2)	4.8	78 (764.9)
			30	94-1830	13.47	7.2		6.5		5.8	
			35	94-1835	11.54	8.4		7.5		6.7	
			40	94-1840	10.10	9.6		8.6		7.7	
			45	94-1845	8.98	10.8		9.7		8.6	
			50	94-1850	8.08	12.0		10.8		9.6	
			55	94-1855	7.34	13.2		11.8		10.6	
			60	94-1860	6.73	14.4		13.0		11.5	
			65	94-1865	6.21	15.6		14.0		12.5	
			70	94-1870	5.77	16.8		15.1		13.4	
			75	94-1875	5.39	18.0		16.2		14.4	
			80	94-1880	5.05	19.2		17.3		15.4	
			90	94-1890	4.50	21.6		19.4		17.3	
100	94-18100	4.04	24.0	21.6	19.2						
20	10	4.5 x 3.1	25	94-2025	20.00	6.0	120 (1176.8)	5.4	108 (1059.1)	4.8	96 (941.4)
			30	94-2030	16.66	7.2		6.5		5.8	
			35	94-2035	14.28	8.4		7.5		6.7	
			40	94-2040	12.50	9.6		8.6		7.7	
			45	94-2045	11.11	10.8		9.7		8.6	
			50	94-2050	10.00	12.0		10.8		9.6	
			55	94-2055	9.09	13.2		11.8		10.6	
			60	94-2060	8.33	14.4		13.0		11.5	
			65	94-2065	7.69	15.6		14.0		12.5	
			70	94-2070	7.14	16.8		15.1		13.4	
			75	94-2075	6.67	18.0		16.2		14.4	
			80	94-2080	6.25	19.2		17.3		15.4	
			90	94-2090	5.55	21.6		19.4		17.3	
100	94-20100	5.00	24.0	21.6	19.2						
125	94-20125	4.00	30.0	27.0	24.0						
150	94-20150	3.33	36.0	32.4	28.8						
22	11	5.1 x 3.4	25	94-2225	24.16	6.0	145 (1422.0)	5.4	130 (1274.9)	4.8	116 (1137.6)
			30	94-2230	20.13	7.2		6.5		5.8	
			35	94-2235	17.30	8.4		7.5		6.7	
			40	94-2240	15.10	9.6		8.6		7.7	
			45	94-2245	13.40	10.8		9.7		8.6	
			50	94-2250	12.08	12.0		10.8		9.6	
			55	94-2255	10.94	13.2		11.8		10.6	
			60	94-2260	10.06	14.4		13.0		11.5	
			65	94-2265	9.28	15.6		14.0		12.5	
			70	94-2270	8.63	16.8		15.1		13.4	
			75	94-2275	8.04	18.0		16.2		14.4	
			80	94-2280	7.55	19.2		17.3		15.4	
			90	94-2290	6.71	21.6		19.4		17.3	
100	94-22100	6.04	24.0	21.6	19.2						
125	94-22125	4.83	30.0	27.0	24.0						
150	94-22150	4.02	36.0	32.4	28.8						

JIS Heavy Load Springs

Rectangular Wire Construction

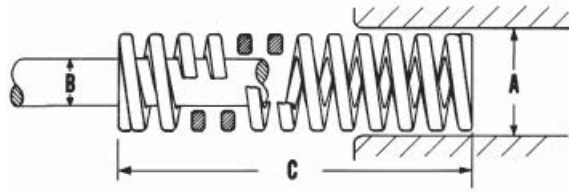

* Note: 1 daN = 1.0197 Kg (Force)

Outer Diam. (mm) A	Inner Diam. (mm) B	Wire Size (mm)	Free Length (mm) C	Catalog Number	Spring *Rate kgf/mm	LOAD-DEFLECTION TABLE					
						0.3 million		0.5 million		1 million	
						Deflection mm	Load kgf (N)	Deflection mm	Load kgf (N)	Deflection mm	Load kgf (N)
25	12.5	5.8 x 3.9	25	94-2525	31.20	6.0	187 (1833.8)	5.4	169 (1657.0)	4.8	150 (1471.0)
			30	94-2530	25.97	7.2		6.5		5.8	
			35	94-2535	22.38	8.4		7.5		6.7	
			40	94-2540	19.47	9.6		8.6		7.7	
			45	94-2545	17.40	10.8		9.7		8.6	
			50	94-2550	15.58	12.0		10.8		9.6	
			55	94-2555	14.20	13.2		11.9		10.6	
			60	94-2560	12.98	14.4		13.0		11.5	
			65	94-2565	12.00	15.6		14.0		12.5	
			70	94-2570	11.13	16.8		15.1		13.4	
			75	94-2575	10.40	18.0		16.2		14.4	
			80	94-2580	9.73	19.2		17.3		15.4	
			90	94-2590	8.65	21.6		19.4		17.3	
			100	94-25100	7.79	24.0		21.6		19.2	
			125	94-25125	6.23	30.0		27.0		24.0	
150	94-25150	5.20	36.0	32.4	28.8						
175	94-25175	4.46	42.0	37.8	33.6						
27	13.5	6.3 x 4.2	25	94-2725	36.40	6.0	219 (2147.7)	5.4	197 (1931.9)	4.8	175 (1716.2)
			30	94-2730	30.41	7.2		6.5		5.8	
			35	94-2735	26.20	8.4		7.5		6.7	
			40	94-2740	22.81	9.6		8.6		7.7	
			45	94-2745	20.30	10.8		9.7		8.6	
			50	94-2750	18.25	12.0		10.8		9.6	
			55	94-2755	16.50	13.2		11.9		10.6	
			60	94-2760	15.20	14.4		13.0		11.5	
			65	94-2765	14.00	15.6		14.0		12.5	
			70	94-2770	13.03	16.8		15.1		13.4	
			75	94-2775	12.10	18.0		16.2		14.4	
			80	94-2780	11.40	19.2		17.3		15.4	
			90	94-2790	10.13	21.6		19.4		17.3	
			100	94-27100	9.12	24.0		21.6		19.2	
			125	94-27125	7.30	30.0		27.0		24.0	
150	94-27150	6.08	36.0	32.4	28.8						
175	94-27175	5.21	42.0	37.8	33.6						
30	15	7.1 x 4.4	25	94-3025	45.00	6.0	270 (2647.8)	5.4	243 (2382.4)	4.8	216 (2118.2)
			30	94-3030	37.50	7.2		6.5		5.8	
			35	94-3035	32.26	8.4		7.5		6.7	
			40	94-3040	28.12	9.6		8.6		7.7	
			45	94-3045	25.00	10.8		9.7		8.6	
			50	94-3050	22.50	12.0		10.8		9.6	
			55	94-3055	20.40	13.2		11.9		10.6	
			60	94-3060	18.75	14.4		13.0		11.5	
			65	94-3065	17.30	15.6		14.0		12.5	
			70	94-3070	16.07	16.8		15.1		13.4	
			75	94-3075	15.00	18.0		16.2		14.4	
			80	94-3080	14.06	19.2		17.3		15.4	
			90	94-3090	12.50	21.6		19.4		17.3	
			100	94-30100	11.25	24.0		21.6		19.2	
			125	94-30125	9.00	30.0		27.0		24.0	
150	94-30150	7.50	36.0	32.4	28.8						
175	94-30175	6.42	42.0	37.8	33.6						
200	94-30200	5.62	48.0	43.2	38.4						

JIS Heavy Load Springs

* Note: 1 daN = 1.0197 Kg (Force)

Outer Diam. (mm) A	Inner Diam. (mm) B	Wire Size (mm)	Free Length (mm) C	Catalog Number	Spring *Rate kgf/mm	LOAD-DEFLECTION TABLE											
						0.3 million		0.5 million		1 million							
						Deflection mm	Load kgf (N)	Deflection mm	Load kgf (N)	Deflection mm	Load kgf (N)						
35	17.5	8.3 x 5.2	40	94-3540	38.22	9.6	367 (3599.0)	8.6	330 (3236.2)	7.7	293 (2873.4)						
			45	94-3545	33.98	10.8		9.7		8.6							
			50	94-3550	30.58	12.0		10.8		9.6							
			55	94-3555	27.80	13.2		11.9		10.5							
			60	94-3560	25.48	14.4		13.0		11.5							
			65	94-3565	23.53	15.6		14.0		12.5							
			70	94-3570	21.84	16.8		15.1		13.4							
			75	94-3575	20.39	18.0		16.2		14.4							
			80	94-3580	19.11	19.2		17.3		15.4							
			90	94-3590	16.99	21.6		19.4		17.3							
			100	94-35100	15.29	24.0		21.6		19.2							
			125	94-35125	12.23	30.0		27.0		24.0							
			150	94-35150	10.19	36.0		32.4		28.8							
			175	94-35175	8.73	42.0		37.8		33.6							
200	94-35200	7.64	48.0	43.2	38.4												
40	20	9.3 x 6.1	40	94-4040	50.00	9.6	480 (4707.2)	8.6	432 (4236.5)	7.7	384 (3765.8)						
			50	94-4050	40.00	12.0		10.8		9.6							
			60	94-4060	33.33	14.4		13.0		11.5							
			70	94-4070	28.57	16.8		15.1		13.4							
			80	94-4080	25.00	19.2		17.3		15.4							
			90	94-4090	22.22	21.6		19.4		17.3							
			100	94-40100	20.00	24.0		21.6		19.2							
			125	94-40125	16.00	30.0		27.0		24.0							
			150	94-40150	13.33	36.0		32.4		28.8							
			175	94-40175	11.42	42.0		37.8		33.6							
			200	94-40200	10.00	48.0		43.2		38.4							
			250	94-40250	8.00	60.0		54.0		48.0							
			50	25	11.8 x 7.8	50		94-5050		62.50		12.0	750 (7355.0)	10.8	675 (6619.5)	9.6	600 (5884.0)
						60		94-5060		52.08		14.4		13.0		11.5	
70	94-5070	44.64				16.8	15.1	13.4									
80	94-5080	39.06				19.2	17.3	15.4									
90	94-5090	34.72				21.6	19.4	17.3									
100	94-50100	32.25				24.0	21.6	19.2									
125	94-50125	25.00				30.0	27.0	24.0									
150	94-50150	20.83				36.0	32.4	28.8									
175	94-50175	17.85				42.0	37.8	33.6									
200	94-50200	15.62				48.0	43.2	38.4									
250	94-50250	12.50				60.0	54.0	48.0									
300	94-50300	10.41				72.0	64.8	57.6									
60	30	14.5 x 9.3				60	94-6060	75.00	14.4	1080 (10591.2)	13.0	973 (9541.9)		11.5		864 (8473.0)	
						70	94-6070	64.28	16.8		15.1			13.4			
			80	94-6080	56.25	19.2	17.3	15.4									
			90	94-6090	50.00	21.6	19.4	17.3									
			100	94-60100	45.00	24.0	21.6	19.2									
			125	94-60125	36.00	30.0	27.0	24.0									
			150	94-60150	30.00	36.0	32.4	28.8									
			175	94-60175	25.71	42.0	37.8	33.6									
			200	94-60200	22.50	48.0	43.2	38.4									
			250	94-60250	18.00	60.0	54.0	48.0									
			300	94-60300	15.00	72.0	64.8	57.6									

JIS Extra-Heavy Load Springs

Rectangular Wire Construction

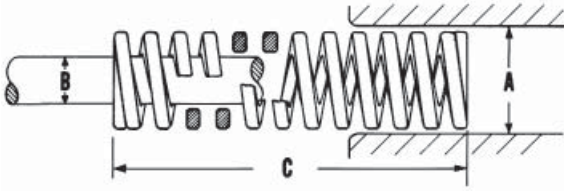

* Note: 1 daN = 1.0197 Kg (Force)

Outer Diam. (mm) A	Inner Diam. (mm) B	Wire Size (mm)	Free Length (mm) C	Catalog Number	Spring *Rate kgf/mm	LOAD-DEFLECTION TABLE					
						0.3 million		0.5 million		1 million	
						Deflection mm	Load kgf (N)	Deflection mm	Load kgf (N)	Deflection mm	Load kgf (N)
10	5	2.1 x 2.1	20	95-1020	11.25	4.0	45 (441.2)	3.6	40.5 (397.1)	3.2	36 (353.0)
			25	95-1025	9.00	5.0		4.5		4.0	
			30	95-1030	7.50	6.0		5.4		4.8	
			35	95-1035	6.43	7.0		6.3		5.6	
			40	95-1040	5.63	8.0		7.2		6.4	
			45	95-1045	5.00	9.0		8.1		7.2	
			50	95-1050	4.50	10.0		9.0		8.0	
			55	95-1055	4.09	11.0		9.9		8.8	
			60	95-1060	3.75	12.0		10.8		9.6	
			65	95-1065	3.47	13.0		11.7		10.4	
			70	95-1070	3.21	14.0		12.6		11.2	
			75	95-1075	3.00	15.0		13.5		12.0	
			80	95-1080	2.82	16.0		14.4		12.8	
12	6	2.7 x 2.5	20	95-1220	14.50	4.0	58 (568.6)	3.6	52 (509.8)	3.2	46.4 (454.9)
			25	95-1225	11.60	5.0		4.5		4.0	
			30	95-1230	9.67	6.0		5.4		4.8	
			35	95-1235	8.29	7.0		6.3		5.6	
			40	95-1240	7.25	8.0		7.2		6.4	
			45	95-1245	6.44	9.0		8.1		7.2	
			50	95-1250	5.80	10.0		9.0		8.0	
			55	95-1255	5.27	11.0		9.9		8.8	
			60	95-1260	4.83	12.0		10.8		9.6	
			65	95-1265	4.44	13.0		11.7		10.4	
			70	95-1270	4.13	14.0		12.6		11.2	
			75	95-1275	3.85	15.0		13.5		12.0	
			80	95-1280	3.61	16.0		14.4		12.8	
14	7	3.3 x 2.8	25	95-1425	15.00	5.0	75 (735.3)	4.5	67.5 (661.8)	4.0	60 (588.3)
			30	95-1430	12.50	6.0		5.4		4.8	
			35	95-1435	10.72	7.0		6.3		5.6	
			40	95-1440	9.38	8.0		7.2		6.4	
			45	95-1445	8.34	9.0		8.1		7.2	
			50	95-1450	7.50	10.0		9.0		8.0	
			55	95-1455	6.82	11.0		9.9		8.8	
			60	95-1460	6.25	12.0		10.8		9.6	
			65	95-1465	5.77	13.0		11.7		10.4	
			70	95-1470	5.36	14.0		12.6		11.2	
			75	95-1475	5.00	15.0		13.5		12.0	
			80	95-1480	4.69	16.0		14.4		12.8	
			90	95-1490	4.17	18.0		16.2		14.4	
16	8	3.6 x 3.0	25	95-1625	20.00	5.0	100 (981.0)	4.5	90 (883.0)	4.0	80 (785.0)
			30	95-1630	16.67	6.0		5.4		4.8	
			35	95-1635	14.29	7.0		6.3		5.6	
			40	95-1640	12.50	8.0		7.2		6.4	
			45	95-1645	11.11	9.0		8.1		7.2	
			50	95-1650	10.00	10.0		9.0		8.0	
			55	95-1655	9.09	11.0		9.9		8.8	
			60	95-1660	8.34	12.0		10.8		9.6	
			65	95-1665	7.69	13.0		11.7		10.4	
			70	95-1670	7.14	14.0		12.6		11.2	
			75	95-1675	6.67	15.0		13.5		12.0	
			80	95-1680	6.25	16.0		14.4		12.8	
			90	95-1690	5.56	18.0		16.2		14.4	
100	95-16100	5.00	20.0	18.0	16.0						

JIS Extra-Heavy Load Springs

* Note: 1 daN = 1.0197 Kg (Force)

Outer Diam. (mm) A	Inner Diam. (mm) B	Wire Size (mm)	Free Length (mm) C	Catalog Number	Spring *Rate kgf/mm	LOAD-DEFLECTION TABLE					
						0.3 million		0.5 million		1 million	
						Deflection mm	Load kgf (N)	Deflection mm	Load kgf (N)	Deflection mm	Load kgf (N)
18	9	4.1 x 3.5	25	95-1825	25.00	5.0	125 (1226.0)	4.5	113 (1108.0)	4.0	100 (981.0)
			30	95-1830	20.84	6.0		5.4		4.8	
			35	95-1835	17.86	7.0		6.3		5.6	
			40	95-1840	15.63	8.0		7.2		6.4	
			45	95-1845	13.89	9.0		8.1		7.2	
			50	95-1850	12.50	10.0		9.0		8.0	
			55	95-1855	11.37	11.0		9.9		8.8	
			60	95-1860	10.42	12.0		10.8		9.6	
			65	95-1865	9.62	13.0		11.7		10.4	
			70	95-1870	8.93	14.0		12.6		11.2	
			75	95-1875	8.34	15.0		13.5		12.0	
			80	95-1880	7.82	16.0		14.4		12.8	
			90	95-1890	6.95	18.0		16.2		14.4	
100	95-18100	6.26	20.0	18.0	16.0						
20	10	4.7 x 3.7	25	95-2025	32.00	5.0	160 (1569.1)	4.5	144 (1412.2)	4.0	128 (1255.3)
			30	95-2030	26.67	6.0		5.4		4.8	
			35	95-2035	22.86	7.0		6.3		5.6	
			40	95-2040	20.00	8.0		7.2		6.4	
			45	95-2045	17.78	9.0		8.1		7.2	
			50	95-2050	16.00	10.0		9.0		8.0	
			55	95-2055	14.55	11.0		9.9		8.8	
			60	95-2060	13.33	12.0		10.8		9.6	
			65	95-2065	12.31	13.0		11.7		10.4	
			70	95-2070	11.43	14.0		12.6		11.2	
			75	95-2075	10.67	15.0		13.5		12.0	
			80	95-2080	10.00	16.0		14.4		12.8	
			90	95-2090	8.89	18.0		16.2		14.4	
100	95-20100	8.00	20.0	18.0	16.0						
125	95-20125	6.40	25.0	22.5	20.0						
150	95-20150	5.33	30.0	27.0	24.0						
22	11	5.2 x 4.2	25	95-2225	39.00	5.0	195 (1912.0)	4.5	176 (1726.0)	4.0	156 (1530.0)
			30	95-2230	32.50	6.0		5.4		4.8	
			35	95-2235	27.86	7.0		6.3		5.6	
			40	95-2240	24.38	8.0		7.2		6.4	
			45	95-2245	21.67	9.0		8.1		7.2	
			50	95-2250	19.50	10.0		9.0		8.0	
			55	95-2255	17.73	11.0		9.9		8.8	
			60	95-2260	16.25	12.0		10.8		9.6	
			65	95-2265	15.00	13.0		11.7		10.4	
			70	95-2270	13.93	14.0		12.6		11.2	
			75	95-2275	13.00	15.0		13.5		12.0	
			80	95-2280	12.19	16.0		14.4		12.8	
			90	95-2290	10.83	18.0		16.2		14.4	
100	95-22100	9.75	20.0	18.0	16.0						
125	95-22125	7.80	25.0	22.5	20.0						
150	95-22150	6.50	30.0	27.0	24.0						

JIS Extra-Heavy Load Springs

Rectangular Wire Construction

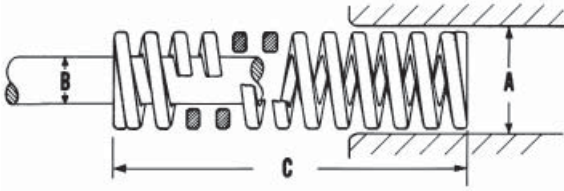

* Note: 1 daN = 1.0197 Kg (Force)

Outer Diam. (mm) A	Inner Diam. (mm) B	Wire Size (mm)	Free Length (mm) C	Catalog Number	Spring *Rate kgf/mm	LOAD-DEFLECTION TABLE					
						0.3 million		0.5 million		1 million	
						Deflection mm	Load kgf (N)	Deflection mm	Load kgf (N)	Deflection mm	Load kgf (N)
25	12.5	5.8 x 4.6	25	95-2525	49.00	5.0	245 (2402.6)	4.5	221 (2167.3)	4.0	196 (1922.1)
			30	95-2530	40.80	6.0		5.4		4.8	
			35	95-2535	35.00	7.0		6.3		5.6	
			40	95-2540	30.60	8.0		7.2		6.4	
			45	95-2545	27.20	9.0		8.1		7.2	
			50	95-2550	24.50	10.0		9.0		8.0	
			55	95-2555	22.30	11.0		9.9		8.8	
			60	95-2560	20.40	12.0		10.8		9.6	
			65	95-2565	18.80	13.0		11.7		10.4	
			70	95-2570	17.50	14.0		12.6		11.2	
			75	95-2575	16.30	15.0		13.5		12.0	
			80	95-2580	15.30	16.0		14.4		12.8	
			90	95-2590	13.60	18.0		16.2		14.4	
			100	95-25100	12.30	20.0		18.0		16.0	
			125	95-25125	9.80	25.0		22.5		20.0	
150	95-25150	8.17	30.0	27.0	24.0						
175	95-25175	7.00	35.0	31.5	28.0						
27	13.5	6.4 x 5.0	25	95-2725	58.00	5.0	290 (2844.0)	4.5	261 (2560.0)	4.0	232 (2275.0)
			30	95-2530	48.33	6.0		5.4		4.8	
			35	95-2735	41.43	7.0		6.3		5.6	
			40	95-2740	36.25	8.0		7.2		6.4	
			45	95-2745	32.22	9.0		8.1		7.2	
			50	95-2750	29.00	10.0		9.0		8.0	
			55	95-2755	26.36	11.0		9.9		8.8	
			60	95-2760	24.17	12.0		10.8		9.6	
			65	95-2765	22.31	13.0		11.7		10.4	
			70	95-2770	20.71	14.0		12.6		11.2	
			75	95-2775	19.33	15.0		13.5		12.0	
			80	95-2780	18.13	16.0		14.4		12.8	
			90	95-2790	16.11	18.0		16.2		14.4	
			100	95-27100	14.50	20.0		18.0		16.0	
			125	95-27125	11.60	25.0		22.5		20.0	
150	95-27150	9.67	30.0	27.0	24.0						
175	95-27175	8.28	35.0	31.5	28.0						
30	15	7.1 x 5.3	25	95-3025	72.00	5.0	360 (3530.4)	4.5	324 (3177.4)	4.0	288 (2824.3)
			30	95-3030	60.00	6.0		5.4		4.8	
			35	95-3035	51.43	7.0		6.3		5.6	
			40	95-3040	45.00	8.0		7.2		6.4	
			45	95-3045	40.00	9.0		8.1		7.2	
			50	95-3050	36.00	10.0		9.0		8.0	
			55	95-3055	32.72	11.0		9.9		8.8	
			60	95-3060	30.00	12.0		10.8		9.6	
			65	95-3065	27.69	13.0		11.7		10.4	
			70	95-3070	25.71	14.0		12.6		11.2	
			75	95-3075	24.00	15.0		13.5		12.0	
			80	95-3080	22.50	16.0		14.4		12.8	
			90	95-3090	20.00	18.0		16.2		14.4	
			100	95-30100	18.00	20.0		18.0		16.0	
			125	95-30125	14.40	25.0		22.5		20.0	
			150	95-30150	12.00	30.0		27.0		24.0	
			175	95-30175	10.28	35.0		31.5		28.0	
200	95-30200	9.00	40.0	36.0	32.0						

JIS Extra-Heavy Load Springs

* Note: 1 daN = 1.0197 Kg (Force)

Outer Diam. (mm) A	Inner Diam. (mm) B	Wire Size (mm)	Free Length (mm) C	Catalog Number	Spring *Rate kgf/mm	LOAD-DEFLECTION TABLE											
						0.3 million		0.5 million		1 million							
						Deflection mm	Load kgf (N)	Deflection mm	Load kgf (N)	Deflection mm	Load kgf (N)						
35	17.5	8.3 x 6.6	40	95-3540	61.25	8.0	490 (4805.3)	7.2	441 (4324.7)	6.4	392 (3844.2)						
			45	95-3545	54.44	9.0		8.1		7.2							
			50	95-3550	49.00	10.0		9.0		8.0							
			55	95-3555	44.54	11.0		9.9		8.8							
			60	95-3560	40.83	12.0		10.8		9.6							
			65	95-3565	37.69	13.0		11.7		10.4							
			70	95-3570	35.00	14.0		12.6		11.2							
			75	95-3575	32.67	15.0		13.5		12.0							
			80	95-3580	30.62	16.0		14.4		12.8							
			90	95-3590	27.22	18.0		16.2		14.4							
			100	95-35100	24.50	20.0		18.0		16.0							
			125	95-35125	19.60	25.0		22.5		20.0							
			150	95-35150	16.33	30.0		27.0		24.0							
			175	95-35175	14.00	35.0		31.5		28.0							
			200	95-35200	12.25	40.0		36.0		32.0							
40	20	9.8 x 7.5	40	95-4040	80.00	8.0	640 (6276.3)	7.2	576 (5648.6)	6.4	512 (5021.0)						
			50	95-4050	64.00	10.0		9.0		8.0							
			60	95-4060	53.33	12.0		10.8		9.6							
			70	95-4070	45.71	14.0		12.6		11.2							
			80	95-4080	40.00	16.0		14.4		12.8							
			90	95-4090	35.55	18.0		16.2		14.4							
			100	95-40100	32.00	20.0		18.0		16.0							
			125	95-40125	25.60	25.0		22.5		20.0							
			150	95-40150	21.33	30.0		27.0		24.0							
			175	95-40175	18.28	35.0		31.5		28.0							
			200	95-40200	16.00	40.0		36.0		32.0							
			250	95-40250	12.80	50.0		45.0		40.0							
			50	25	12.0 x 8.8	50		95-5050		100.00		10.0	1000 (9806.7)	9.0	900 (8826.0)	8.0	800 (7845.3)
						60		95-5060		83.33		12.0		10.8		9.6	
						70		95-5070		71.42		14.0		12.6		11.2	
80	95-5080	62.50				16.0	14.4	12.8									
90	95-5090	55.55				18.0	16.2	14.4									
100	95-50100	50.00				20.0	18.0	16.0									
125	95-50125	40.00				25.0	22.5	20.0									
150	95-50150	33.33				30.0	27.0	24.0									
175	95-50175	28.57				35.0	31.5	28.0									
200	95-50200	25.00				40.0	36.0	32.0									
250	95-50250	20.00				50.0	45.0	40.0									
300	95-50300	16.66				60.0	54.0	48.0									
60	30	14.8 X 10.5				60	95-6060	120.00	12.0	1440 (14121.6)	10.8	1296 (12709.4)		9.6		1152 (11297.3)	
						70	95-6070	102.86	14.0		12.6			11.2			
						80	95-6080	90.00	16.0		14.4			12.8			
			90	95-6090	80.00	18.0	16.2	14.4									
			100	95-60100	72.00	20.0	18.0	16.0									
			125	95-60125	57.60	25.0	22.5	20.0									
			150	95-60150	48.00	30.0	27.0	24.0									
			175	95-60175	41.14	35.0	31.5	28.0									
			200	95-60200	36.00	40.0	36.0	32.0									
			250	95-60250	28.80	50.0	45.0	40.0									
300	95-60300	24.00	60.0	54.0	48.0												

Spring Accessories

Spring Retainers

Spring retainers hold individual springs firmly in position while the die is being assembled or disassembled. When a die is disassembled for repairs, only springs needing replacement are released.

Reloading is easy since springs can be set individually, which avoids working against the combined force of a number of springs. Retainers are all-steel construction with a bright zinc plate finish. They can be used with springs having rod diameters of 20mm and 25mm and any length that permits clearance.

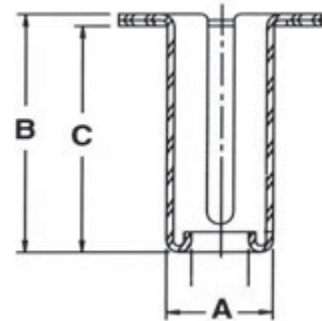
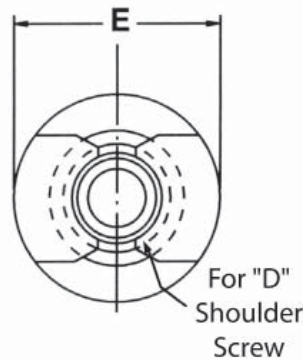
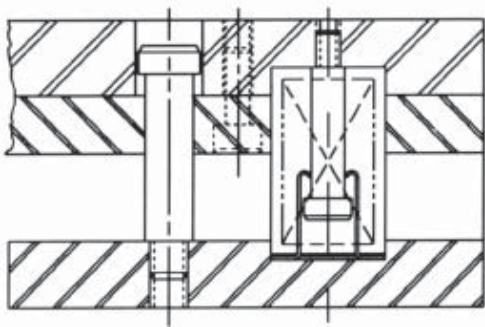

Catalog Number	A (mm)	B (mm)	C (mm)	D (mm)	E (mm)	F (mm)	G (mm)	H (mm)
9-20048-16	20	48	45	10	37	4	1.3	15.8
9-25048-16	25	48	44	13.5	49	3	2	21.5
9-25073-16	25	73	70	13.5	49	3	2	21.5

Notes

Notes

JIS SPRINGS

THE BRANDS YOU TRUST



- Speed, Reliability and Accuracy
- Competitive Prices
- High Quality Design and Construction
- Outstanding Service and Support

Anchor Danly

Distributed by:



Anchor Danly
The Brands You Trust

www.anchorandany.com

COMPONENTS (DANLY, IEM, LAMINA & LEMPCO)

DANLY, IEM, LAMINA & LEMPCO Farmington Hills, MI CALL: 800-652-6462 FAX: 800-406-4410 info@anchorandany.com	PUNCHRITE Hamilton, OH CALL: 800-232-6592 FAX: 800-432-6594 punchproducts@anchorandany.com
---	---

DIE SETS, STEEL PLATE (GROUND & MACHINED) & FABRICATIONS

ANCHOR DIE SETS USA Detroit, MI CALL: 800-543-3790 FAX: 800-963-0400 wineng@anchorandany.com	ANCHOR DIE SETS USA Grand Rapids, MI CALL: 888-526-2467 FAX: 616-949-9580 graeng@anchorandany.com
ANCHOR DIE SETS Montreal, QC, Canada CALL: 800-263-5560 FAX: 514-525-7835 moneng@anchorandany.com	ANCHOR DIE SETS Cambridge, ON, Canada CALL: 800-265-7842 FAX: 519-740-8213 cooeng@anchorandany.com
ANCHOR DIE SETS Windsor, ON, Canada CALL: 800-265-5007 FAX: 519-966-3594 wineng@anchorandany.com	DANLY IEM Ithaca, MI & Los Angeles, CA CALL: 800-243-2659 FAX: 800-833-2659 quotes@danly.com
LEMPCO Ithaca, MI & Los Angeles, CA CALL: 800-321-8632 FAX: 800-221-6310 quotes@lempco.com	RELIANCE FABRICATIONS Tilbury, ON, Canada CALL: 800-265-5295 FAX: 519-682-3616 releng@anchorandany.com



OUTSIDE THE USA & CANADA:

CALL: 001-248-489-7816 • FAX: 001-248-553-6842