



## Hydraulic Equipment

## Portable Hydraulic Die Setter & Drilling & Tapping Equipment



Lamina has moved into the new millennium with upgraded, user friendly electronic technology. These products are more efficient, quieter and easy to use.

**Drilling Equipment** – Product offering includes: Heavy-duty, portable hydraulic power unit and a choice of six drill heads which work interchangeably with the power unit.

**Die Setting Equipment** – Product offering includes: Heavy-duty, portable hydraulic Die Setter with retractable hose reels, a choice of hydraulic cylinders, and a set of cribbing rings and pads. Available with four or six cylinders.

**Die Separating Equipment** – Product offering includes: Heavy-duty, portable hydraulic Die Separator with retractable hose reels, a choice of hydraulic cylinders and a set of cribbing rings and pads.

## Table of Contents

General Information.....	2-3
Power Unit.....	4
Drill Heads	
A10048SH, #1 Stub.....	5
A10048SH Accessories, Drills, Taps, Adaptors ..	5
A10048H, #1 Morse.....	5
B10065H, #3 Morse.....	6
B10065P, #3 Morse.....	6
B15075P, #4 Morse.....	7
H15010P, #5 Morse.....	7
Die Setter, Four Cylinder Model.....	8
Die Setter, Six Cylinder Model.....	9
Die Separator.....	10
Die Setter accessories.....	11
Power Unit Accessories.....	12
Drill Head Replacement Parts.....	13
Die Setter and Separator Parts.....	15
Rental & Service Information.....	16

## Industries Served:

- **Metal Stamping**
- **Nuclear Power**
- **Ship Building**
- **Mining**
- **Construction**
- **Oil Pipelines**
- **Oil Rigging**
- **Bridge Building**

**For over 50 years, Lamina is the name in portable hydraulic drilling equipment.**

The **Lamina Portable Heavy-Duty Drill** is versatile enough to go almost anywhere, providing continuous heavy duty drilling and tapping, even in the most cramped quarters. The compact drill delivers remarkable power in openings as narrow as 9-1/4". Furthermore, the drill's magnetic base attaches to the drilling surface at almost any angle, including vertically and horizontally.

**The Experienced Edge.** Lamina has long been recognized as a leader in portable hydraulic drill technology. For over 50 years, Lamina has provided a cross-section of American industry with a durable, high-power portable drill. Our team of engineers have combined power and portability in a single drill, allowing it to effectively function in a broad spectrum of applications.

Lamina takes pride in its superior quality. Before any Lamina Drill is shipped, it is tested by drilling a hole at its maximum capacity.

Now with the addition of electronics the unit exceeds former expectations and offers more power and efficiency, automatic hose reels, more safety features and lower noise level.

The **Portable Heavy-Duty Electronic/Hydraulic Die Setter** is an important addition to the Lamina Hydraulic Equipment line. This unit has truly proved itself since it was first offered in 1998.

Owners of the Lamina Die Setter are pleased with its low maintenance, dependability and high load capabilities. The electronics help maintain precise levels when raising and lowering the most-off center weight distribution.

The Six Cylinder Die Setter was designed and developed for oversized dies that require extra lift at the center to keep the die level during separation.

For those applications where precision is not an issue and where the need is only to separate dies, a **Portable Heavy-Duty Hydraulic Die Separator** is available which includes all the features of the Portable Heavy-Duty Die Setter without the electronics.

Lamina Hydraulic Equipment features rugged steel construction. It is built to last and take rough handling. With the lifting bales these units are portable enough to be placed almost anywhere they are needed.

## Hydraulic Power Unit

Compact cart is easily moved right to the job site. It is 44.5 inches long x 24.5 inches wide x 54.5 inches high, mounted on casters, equipped with 15 feet of hydraulic pressure hoses and quick disconnect fittings. Electrical controls conform to National Electrical Manufacturers Association (N.E.M.A.) standards, complete with start and stop controls, and a remote pendant speed control. The main electrical panel includes a 12V 60 amp, deep cycle battery with rectifier charger operating from voltage listed in table below. Complete with oil, hoses and connectors. Remote speed control is standard. An optional 110V AC, single phase 15 amp outlet can be included by adding the suffix "-OUTLET" to the end of the part number.

### • Control console complete with:

- Battery Voltage Gage
- Oil Pressure Gage
- Power Indicator Light
- Electronic Oil Level Display
- Hour Meter
- Emergency Stop Button
- 15 feet of hydraulic hoses on Power Unit
- 7-1/2 feet of hydraulic hoses on Drill head
- 30 feet of electrical cable to cart
- 30 feet of control cable to pendant box
- 6 feet of cable on drill head to pendant box
- Maximum flow rate of 12 gallons per minute (GPM)
- Standard Operating Pressure of 1550–1600 pounds per square inch (PSI)
- Oil required: Mobil<sup>®</sup> DTE-10 Excel 32 (15 gallons) (ISO 32)
- Back-up Battery Gel Cell 60 amp Deep Cycle
- Foot Brake
- Lifting Bale

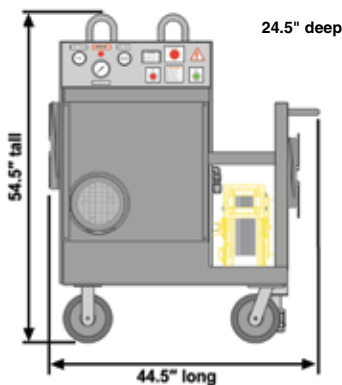

Our standard remote speed regulator can change speeds (GPM) remotely and conveniently by merely pushing the increase or decrease button on the pendant control.

There is no loss of magnetic force if service power fails; 12-volt battery automatically supplies current for magnet. Automatic battery charger maintains top level charge in battery (audio alert when not charging).

Oil is always radiator-cooled before returning to tank.

By-pass valve prevents tap breakage when unusual load conditions are present, and permits bottoming tap within recommended range of each head.

In addition, by using a simple shunt device, the unit may be used in any number of applications requiring a hydraulic power unit. To order this shunt device, please specify part number ASSY-21. This shunt device is required for drills ordered without a magnetic base (-NMB).

Part #	Three Phase Voltage	Hz	Shipping Weights Pounds		Crate Dimensions (inches)
			with oil	without oil	
HPU220	220	60	1050	950	59 H x 38 W x 66 L
HPU440	440	60	1050	950	59 H x 38 W x 66 L
HPU600	600	60	1050	950	59 H x 38 W x 66 L
HPU380	380	50	1130	1030	59 H x 38 W x 66 L

Safety devices should be used when drilling horizontally or overhead. See Power Unit Manual for safety and instructions.



## Drill Heads A10048SH & A10048H

- Compact – smaller head available in two column lengths
- Drills up to 13/16 inch (20.64mm) in solid steel without pilot hole
- Drills up as well as down, even horizontally
- Fits in tight spaces
- Rugged

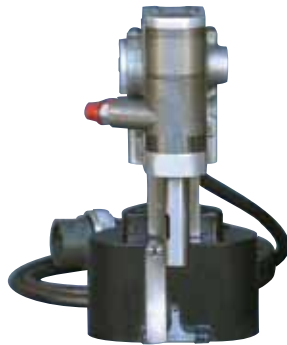

A10048SH  
#1 Stub Taper



A10048H  
#1 Morse Taper

- Drill Capacity–AISI 1020 Steel 13/16 Inch Diameter
- Tap Capacity–AISI 1020 Steel 3/4–10 threads per inch
- Motor Horsepower 5.21 Hp
- Maximum Torque 525 inch pounds
- Variable R.P.M. to 625 RPM
- Feed Method Hand
- Tool Shank A10048SH #1 Stub Taper
- Tool Shank A10048H #1 Morse Taper
- Magnet Capacity (Pull Force) 1200 pounds force
- Magnet Size 4-7/8 inches
- Weight A10048SH 22 pounds
- Shipping Weight A10048SH 28 pounds
- Crate Dimensions A10048SH:
  - Height 9-1/4 inches
  - Width 9-1/4 inches
  - Length 10-3/4 inches
- Weight A10048H 26 pounds
- Shipping Weight A10048H 33 pounds
- Crate Dimensions A10048H:
  - Height 9-1/4 inches
  - Width 9-1/4 inches
  - Length 15 inches
- Old Serial Number Prefix CH

Drilling or tapping cannot begin until the magnet is turned on.

Step drilling of slightly larger diameter holes is possible.

**Note:** "G" dimension is from the center of the spindle to the front of the magnet base.

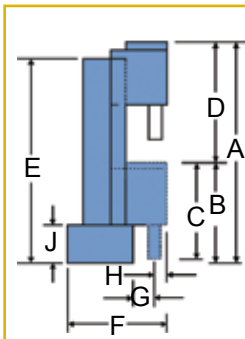





	A10048SH	A10048H
A	10-5/8	15-1/2
B	7-1/2	7-1/2
C	7-1/8	7-1/8
Stroke D	3-1/8	8
Height E	9-1/4	13-3/4
Depth F	7	7
G	11/16	11/16
H	1	1
J	2.900	2.900
Width	4-7/8	4-7/8

Drill heads can be fixtured for special applications.

Drill heads can be ordered without magnetic bases. Please specify "-NMB" suffix.

**Note:** All dimensions are in inches.

Drills, Taps & Adaptors for Lamina Drill Head A10048SH									
Drills & Taps	INCH				METRIC				Adaptors
	Drill Number*	Flute Dia.	Flute Length	Overall Length	Drill Number	Flute Dia.	Flute Length	Overall Length	
 Lamina Drills #1 Stub Taper Exclusive to Lamina	HDD312	.260	1.15	3.12	MD-6.75	6.75	50.80	95.25	 HLDR0000-0075 EXTENSION #1 Stub to #1 Stub
	HDD375	.316	1.62	3.12	MD-8.5	8.5	57.15	95.25	
	HDD500	.432	1.56	3.12	MD-10.2	10.2	66.55	107.95	
	HDD625	.541	2.00	3.56	MD-14.0	14.0	73.15	114.30	
	HDD750	.666	2.38	3.94	MD-17.5	17.5	73.15	114.30	
 Lamina Taps #1 Stub Taper Exclusive to Lamina	Tap Number*	Thread Dia.	Threads per Inch	Thread Length	Tap Number	Thread Dia.	Thread Pitch	Thread Length	 HLDR0000-0076 ADAPTER #3 Morse to #1 Stub
	HDT312	5/16	18	1.38	T-M8	8	1.25	35.05	
	HDT375	3/8	16	1.62	T-M10	10	1.50	41.15	
	HDT500	1/2	13	1.62	T-M12	12	1.75	41.30	
	HDT625	5/8	11	1.88	T-M16	16	2.0	47.75	
HDT750	3/4	10	1.88	T-M20	20	2.5	47.75		

\*Note: The HDD312 drill creates a pilot hole for the HDT312 tap. The other drills and taps have a similar relationship.

Safety devices should be used when drilling horizontally or overhead. See Power Unit Manual for safety and instructions.

## Drill Head B10065H

Drilling or tapping cannot begin until the magnet is turned on.

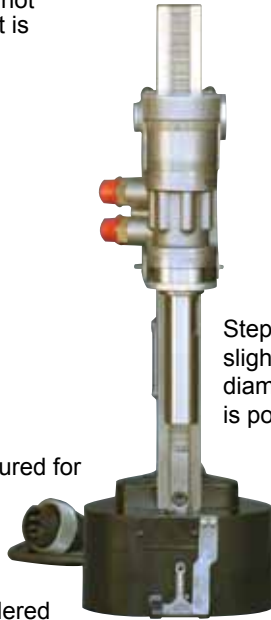

Step drilling of slightly larger diameter holes is possible.

Drill heads can be fixtured for special applications.

Drill heads can be ordered without magnetic bases. Please specify "-NMB" suffix.

**Note:** "G" dimension is from the center of the spindle to the front of the magnet base.

**Note:** All dimensions are in inches.

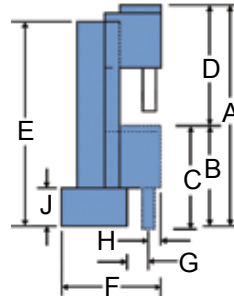

A	21-1/2
B	10-1/16
C	11
Stroke D	11-7/16
Height E	20-3/4
Depth F	9
G	1-3/16
H	1-3/8
J	3-1/2
Width	6-1/2

- Drill Capacity– AISI 1020 Steel
- Tap Capacity– AISI 1020 Steel
- Motor Horsepower
- Maximum Torque
- Variable R.P.M. to
- Feed Method
- Tool Shank
- Magnet Capacity (Pull Force)
- Magnet Size
- Weight
- Shipping Weight
- Crate Dimensions
  - Height
  - Width
  - Length
- Old Serial Number Prefix

- 1 inch diameter (25.4mm)
- 1 inch–8 threads per inch
- 6.64 Hp
- 1000 inch pounds
- 420 RPM
- Hand
- #3 Morse Taper
- 2300 pounds force
- 6-1/2 inches
- 44 pounds
- 68 pounds
- 12 inches
- 11 inches
- 22-1/2 inches
- B

## Drill Head B10065P

Drilling or tapping cannot begin until the magnet is turned on.

Automatic power feed heads can be used both in manual and power feed operations.

Automatic power-feed heads have limit switches that prevent operation of drill head if magnetic base becomes dislodged.

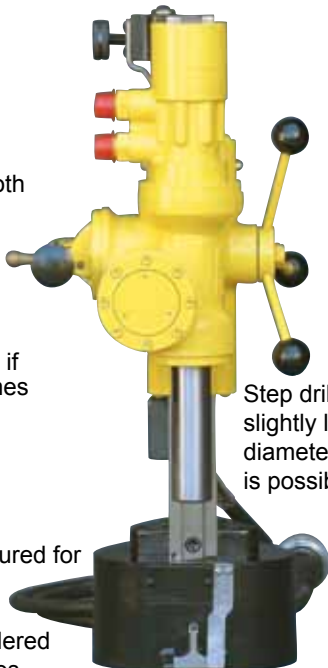

Step drilling of slightly larger diameter holes is possible.

Drill heads can be fixtured for special applications.

Drill heads can be ordered without magnetic bases. Please specify "-NMB" suffix.

**Note:** "G" dimension is from the center of the spindle to the front of the magnet base.

**Note:** All dimensions are in inches.

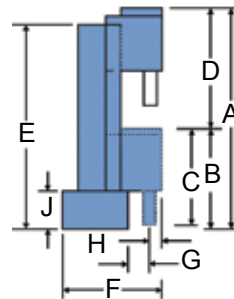

A	26-1/4
B	15-3/8
C	15
Stroke D	10-7/8
Height E	21
Depth F	10-3/4
G	15/16
H	2 -1/4
J	3-1/2
Width	9-3/8

- Drill Capacity– AISI 1020 Steel
- Tap Capacity– AISI 1020 Steel
- Motor Horsepower
- Maximum Torque
- Variable R.P.M. to
- Feed Method
- Optional Power Feed
- Tool Shank
- Magnet Capacity (Pull Force)
- Magnet Size
- Weight
- Shipping Weight
- Crate Dimensions:
  - Height
  - Width
  - Length
- Old Serial Number Prefix

- 1 inch diameter (25.4mm)
- 1 inch–8 threads per inch
- 6.64 Hp
- 1000 inch pounds
- 420 RPM
- Power (.005 inches per revolution)
- .0025 inches per revolution
- #3 Morse Taper
- 2300 pounds force
- 6-1/2 inches
- 54 pounds
- 75 pounds
- 12 inches
- 11 inches
- 22-1/2 inches
- CB

## Drill Head B15075P

Drilling or tapping cannot begin until the magnet is turned on.

Automatic power feed heads can be used both in manual and power feed operations.

Automatic power-feed heads have limit switches that prevent operation of drill head if magnetic base becomes dislodged.

Drill heads can be fixtured for special applications.

Drill heads can be ordered without magnetic bases. Please specify "-NMB" suffix.

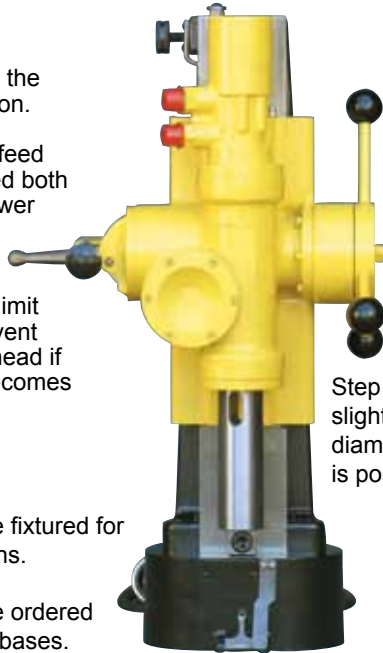

Step drilling of slightly larger diameter holes is possible.

**Note:** "G" dimension is from the center of the spindle to the front of the magnet base.

**Note:** All dimensions are in inches.

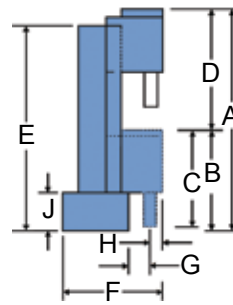

A	30-1/2
B	19-3/8
C	18-3/4
Stroke D	11-1/8
Height E	24
Depth F	10-3/4
G	1
H	2-1/8
J	3-1/2
Width	14

- Drill Capacity—AISI 1020 Steel 1-1/2 inch diameter (38.1mm)
- Tap Capacity—AISI 1020 Steel 1-1/4 inch—7 threads per inch
- Motor Horsepower 6.66 Hp
- Maximum Torque 1400 inch pounds
- Variable R.P.M. to 300 RPM
- Feed Method Power (.0075 inches per revolution)
- Optional Power Feed .0037 inches per revolution
- Tool Shank #4 Morse Taper
- Magnet Capacity (Pull Force) 3200 pounds force
- Magnet Size 7-1/2 inches
- Weight 108 pounds
- Shipping Weight 140 pounds
- Crate Dimensions:
  - Height 14-3/4 inches
  - Width 14-3/4 inches
  - Length 25-1/2 inches
- Old Serial Number Prefix E

## Drill Head H15010P

Drilling or tapping cannot begin until the magnet is turned on.

Automatic power feed heads can be used both in manual and power feed operations.

Automatic power-feed heads have limit switches that prevent operation of drill head if magnetic base becomes dislodged.

Please specify "-OFOM" suffix for optional power feed, optional high torque motor.

Drill heads can be fixtured for special applications.

Drill heads can be ordered without magnetic bases. Please specify "-NMB" suffix.

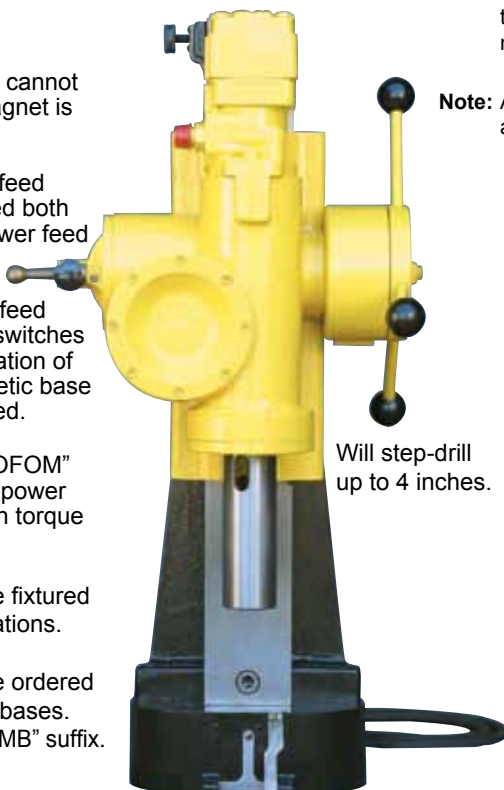

Will step-drill up to 4 inches.

**Note:** "G" dimension is from the center of the spindle to the front of the magnet base.

**Note:** All dimensions are in inches.

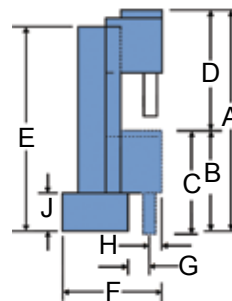

A	41-3/4
B	26-5/8
C	25-1/4
Stroke D	18-3/16
Height E	33-3/8
Depth F	15
G	1-7/8
H	2-5/8
J	3-5/8
Width	17-3/8

- Drill Capacity—AISI 1020 Steel 2 inches (50.8mm) (Standard) (2-1/4" optional)
- Tap Capacity—AISI 1020 Steel 2 inch—6 threads per inch (Standard) (2-3/8" – 8 optional)
- Motor Horsepower 8.30 std./9.48 opt.
- Maximum Torque 4164 in-lbs (std) / 5486 in-lbs (opt)
- Variable R.P.M. to 140 RPM (std) / 108 RPM (opt)
- Feed Method Power (.010 inch per revolution)
- Optional Power Feed .005 inch per revolution
- Tool Shank #5 Morse Taper
- Magnet Capacity (Pull Force) 6000 pounds force
- Magnet size 10 inches
- Weight 255 pounds
- Shipping weight 315 pounds
- Crate Dimensions:
  - Height 24 inches
  - Width 17 inches
  - Length 36 inches
- Old Serial Number Prefix D

## The Go Anywhere, Do-It-All Die Setting Solution

One compact, low-profile, wheeled cabinet contains everything you need for all the punch spotting, die setting, and die separation jobs in your shop.

### Electronic Die Setter – 4 Cylinders



#### Each unit has two modes of operation:

1. Unify Mode – Cylinders will extend until they all contact the die, then they will lift uniformly.
  2. Parallel Mode – Cylinders will all extend at the same rate. To initiate this mode, cylinders must be fully extended or retracted.
- Heavy-duty hydraulic power handles the heaviest dies with state-of-the-art electronic PLC control for precision and accuracy.
  - Handy self-retracting hose reels and control pendant keep every job site neat, and protect hoses and cables from damage.
  - Three different cylinder sizes are available, along with strong, lightweight cribbing blocks to extend their strokes to handle your biggest jobs.
  - Completely portable with large casters and built-in lifting bales, the Lamina Electronic Die Setter is the Go-Anywhere, Do-It-All Die Setting Solution you've been looking for.
  - If you use a tryout press for spotting punches and trim steels, you can free up that tryout press and use our Lamina Electronic Die Setter instead.

Oil required: Mobil<sup>®</sup> DTE-10 Excel 32 (15 gallons)  
(ISO 32)

**Shipping Wt.:** 1375 pounds (with oil)  
1275 pounds (without oil)

**Voltage:** 220V 3 Phase 60 Hz  
440V 3 Phase 60 Hz  
600V 3 Phase 60 Hz  
380V 3 Phase 50 Hz

Dimensions:	UNIT	CRATE
Width (inches)	25	30
Height (inches)	53	56
Length (inches)	50	65

#### Package Includes:

- Die Setter Unit
- Electronic Controls
- 4 cylinders
- 25 feet of hose on each of 4 retractable hose reels
- Pendant control
- 30 feet of electrical cable to cart
- A lower ring, an upper ring and two pads for each cylinder

#### Standard Safety Features

- **Low voltage, three-button pendant for two hand control**
- **Quick Disconnect Fittings**
- **Palm Emergency Stop**
- **Cylinder Safety Lock Cartridge Valves**
- **Cart Foot Brake**
- **Lifting Bales**

Lifting Capacity		
Lifting Mode	Minimum	Maximum
Unify-4 cylinder	2.6 Tons	30 Tons
Parallel-4 cylinder	0 Tons	30 Tons

**Saves time and money!**

**Most economical die setting solution available!**

**WARNING – Always use safety blocks when reaching inside of dies.  
See product manual for safety instructions.**

#### ELECTRONIC DIE SETTER OPTIONS

Die Setter – 4 Cylinder	220V Power Source	380V Power Source	440V Power Source	600V Power Source
With 4 inch Cylinders/Cribbing Blocks	EDS40TKIT4-220	EDS40TKIT4-380	EDS40TKIT4-440	EDS40TKIT4-600
With 6 inch Cylinders/Cribbing Blocks	EDS40TKIT6-220	EDS40TKIT6-380	EDS40TKIT6-440	EDS40TKIT6-600
With 9 inch Cylinders/Cribbing Blocks	EDS40TKIT9-220	EDS40TKIT9-380	EDS40TKIT9-440	EDS40TKIT9-600



## For Larger, Heavier Dies

For oversized dies that require extra lift at the center to keep the die level during separation. Ideal for dies with six safety pad areas.

## Electronic Die Setter – 6 Cylinders



### Each unit has two modes of operation:

1. Unify Mode – Cylinders will extend until they all contact the die, then they will lift uniformly.
  2. Parallel Mode – Cylinders will all extend at the same rate. To initiate this mode, cylinders must be fully extended or retracted.
- Heavy-duty hydraulic power handles the heaviest dies with state-of-the-art electronic PLC control for precision and accuracy.
  - Handy self-retracting hose reels and control pendant keep every job site neat, and protect hoses and cables from damage.
  - Three different cylinder sizes are available, along with strong, lightweight cribbing blocks to extend their strokes to handle your biggest jobs.
  - Completely portable with large casters and built-in lifting bales, the Lamina Electronic Die Setter is the Go-Anywhere, Do-It-All Die Setting Solution you've been looking for.
  - If you use a tryout press for spotting punches and trim steels, you can free up that tryout press and use our Lamina Electronic Die Setter instead.

Oil required: Mobil® DTE-10 Excel 32 (15 gallons) (ISO 32)

**Shipping Wt.:** 1750 pounds (with oil)  
1650 pounds (without oil)

**Voltage:** 220V 3 Phase 60 Hz  
440V 3 Phase 60 Hz  
600V 3 Phase 60 Hz  
380V 3 Phase 50 Hz

Dimensions:	UNIT	CRATE
Width (inches)	25	30
Height (inches)	53	56
Length (inches)	50	65

### Package Includes:

- Die Setter Unit
- Electronic Controls
- 6 cylinders
- 25 feet of hose on each of 6 retractable hose reels
- Pendant control
- 30 feet of electrical cable to cart
- A lower ring, an upper ring and two pads for each cylinder

## Standard Safety Features

- **Low voltage, three-button pendant for two hand control**
- **Quick Disconnect Fittings**
- **Palm Emergency Stop**
- **Cylinder Safety Lock Cartridge Valves**
- **Cart Foot Brake**
- **Lifting Bales**

Lifting Mode	Lifting Capacity	
	Minimum	Maximum
Unify-6 cylinder	3.9 Tons	45 Tons
Parallel-6 cylinder	0 Tons	45 Tons
Unify-4 cylinder	2.6 Tons	30 Tons
Parallel-4 cylinder	0 Tons	30 Tons

**Saves time and money!**

**Most economical die setting solution available!**

**WARNING – Always use safety blocks when reaching inside of dies. See product manual for safety instructions.**

## ELECTRONIC DIE SETTER OPTIONS

Die Setter – 6 Cylinder	220V Power Source	380V Power Source	440V Power Source	600V Power Source
With 4 inch Cylinders/Cribbing Blocks	EDS60TKIT4-220	EDS60TKIT4-380	EDS60TKIT4-440	EDS60TKIT4-600
With 6 inch Cylinders/Cribbing Blocks	EDS60TKIT6-220	EDS60TKIT6-380	EDS60TKIT6-440	EDS60TKIT6-600
With 9 inch Cylinders/Cribbing Blocks	EDS60TKIT9-220	EDS60TKIT9-380	EDS60TKIT9-440	EDS60TKIT9-600

## Introducing a new Die Separator with optional lifting power... An effective solution to your die separating problems.



**Your choice of 15 ton (30,000 pounds) or 30 ton (60,000 pounds) maximum capacity!**

Each unit has two modes of operation:

1. Unify Mode – Cylinders will extend until they all contact the die, then they will lift uniformly.
2. Parallel Mode – Cylinders will all extend at the same rate. To initiate this mode, cylinders must be fully extended or retracted.

- Low voltage, three-button pendant for two hand control
- Controls on console
- Standard Lamina safety features
- Self-retracting hose reels and control pendant
- Three cylinder sizes with cribbing blocks
- Easy-to-roll casters and built-in lifting bales

Oil required: Mobil<sup>®</sup> DTE-10 Excel 32 (15 gallons)  
(ISO 32)

**Shipping Wt.:** 1375 pounds (with oil)  
1275 pounds (without oil)

**Voltage:** 220V 3 Phase 60 Hz  
440V 3 Phase 60 Hz  
600V 3 Phase 60 Hz  
380V 3 Phase 50 Hz

Dimensions:	UNIT	CRATE
Width (inches)	25	30
Height (inches)	53	56
Length (inches)	50	65

**Package Includes:**

- Die Separator Unit
- Mechanical Controls
- 4 cylinders
- 25 feet of hose on each of 4 retractable hose reels
- Pendant control
- 30 feet of electrical cable to cart
- A lower ring, an upper ring and two pads for each cylinder

LIFTING CAPACITY–15 Ton Model		
Lifting Mode	Minimum	Maximum
Unify–4 cylinder	2.6 Tons	15 Tons
Parallel–4 cylinder	0 Tons	15 Tons
LIFTING CAPACITY–30 Ton Model		
Lifting Mode	Minimum	Maximum
Unify–4 cylinder	2.6 Tons	30 Tons
Parallel–4 cylinder	0 Tons	30 Tons

DIE SEPARATOR OPTIONS				
Die Separator 15 ton Capacity	220V Power Source	380V Power Source	440V Power Source	600V Power Source
With 4 inch Cylinders/Cribbing Blocks	LDS20TKIT4-220	LDS20TKIT4-380	LDS20TKIT4-440	LDS20TKIT4-600
With 6 inch Cylinders/Cribbing Blocks	LDS20TKIT6-220	LDS20TKIT6-380	LDS20TKIT6-440	LDS20TKIT6-600
With 9 inch Cylinders/Cribbing Blocks	LDS20TKIT9-220	LDS20TKIT9-380	LDS20TKIT9-440	LDS20TKIT9-600
Die Separator 30 ton Capacity	220V Power Source	380V Power Source	440V Power Source	600V Power Source
With 4 inch Cylinders/Cribbing Blocks	LDS40TKIT4-220	LDS40TKIT4-380	LDS40TKIT4-440	LDS40TKIT4-600
With 6 inch Cylinders/Cribbing Blocks	LDS40TKIT6-220	LDS40TKIT6-380	LDS40TKIT6-440	LDS40TKIT6-600
With 9 inch Cylinders/Cribbing Blocks	LDS40TKIT9-220	LDS40TKIT9-380	LDS40TKIT9-440	LDS40TKIT9-600

**WARNING – Always use safety blocks when reaching inside of dies. See product manual for safety instructions.**

## Hydraulic Cylinders

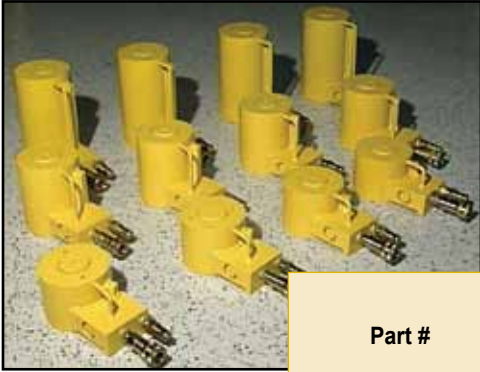

These versatile cylinders come in three stock sizes, 4 inch, 6 inch and 9 inch (closed). They cover a stroke range of 1-1/2 to 6-1/4 inches to serve a large variety of applications. Each cylinder features a convenient carrying handle for ease of set-up and storage. Lamina cylinders incorporate pilot operated safety valves with double hoses and hose guards. Call today to discuss your specific application needs.

Part #	Capacity per Cylinder (pounds)	Total Capacity per 4 Cylinders (pounds)	Total Capacity per 6 Cylinders (pounds)	Closed Shut Height (inches)	Stroke (inches)	Outside Diameter (inches)	Shipping Weight (pounds)
ASSY-40T-4	15,000	60,000	90,000	3-7/8	1-1/2	4-3/4	18
ASSY-40T-6	15,000	60,000	90,000	5-7/8	3-1/4	4-3/4	24
ASSY-40T-9	15,000	60,000	90,000	8-7/8	6-1/4	4-3/4	32
ASSY-40T-4-LDS*	15,000	60,000	N/A	3-7/8	1-1/2	4-3/4	18
ASSY-40T-6-LDS*	15,000	60,000	N/A	5-7/8	3-1/4	4-3/4	24
ASSY-40T-9-LDS*	15,000	60,000	N/A	8-7/8	6-1/4	4-3/4	32
DS210	Universal kit for above Lamina Hydraulic Cylinders						
DS211	Spanner Wrench for removing cylinder caps to access internal seals						
EDS112	Hydraulic Cylinder Check Valve - EDS units only						
EDS112A*	Hydraulic Cylinder Check Valve						

\*Exclusively for Lamina Die Separator (LDS model)

## Cribbing Rings & Pads



**EDS108-1** Lower Cribbing Ring, 1-1/2 inch height

**EDS111** "T" Handle

**EDS109-1** Upper Cribbing Ring, 1-1/8 inch height

**EDS110-1** Cribbing Block Pad, 1-1/8 inch height

1. Extend the cylinder and insert the bottom supporting ring using the "T" handle.
2. Retract the cylinder and insert a pad, again, using the "T" handle.
3. Extend the cylinder again, with the pad increasing the cylinder lift height.
4. Repeat the above process until the desired die separation is attended.

Not more than one Lower Ring, two Upper Rings and three Pads should be used with any one hydraulic cylinder.

For stable load support use Lamina Cribbing Rings and Pads to safely increase the lift height of your Lamina Hydraulic Cylinders. Lamina recommends always using Hydraulic Cylinders with Cribbing Rings and Pads in conjunction with safety blocks when operating the Lamina Die Setter. These cribbing devices can be used with most 4-3/4 inch diameter cylinders with cylinder rods up to 2 inches in diameter.

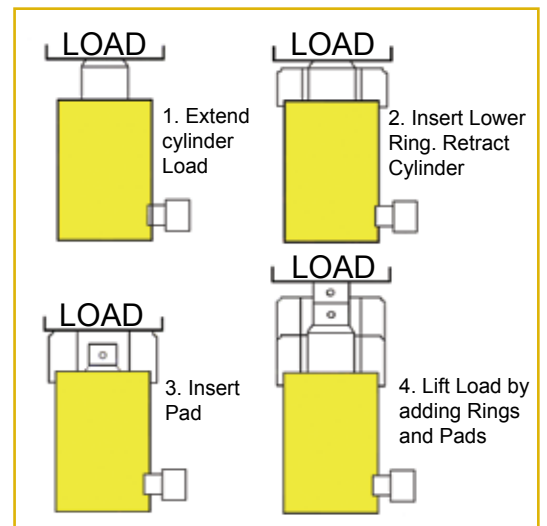

## Hydraulic Power Unit Accessories



### Shunt Device

Part # ASSY-21

This item is needed in applications where the power unit is powering equipment other than Lamina Drill Heads, or in cases where the magnetic base has been removed from a Lamina Drill Head. This easy to use solution screws on the end of the pendant to bypass the controls for the magnetic bases.



### Hydraulic Hose Extension

Lamina provides extension hose assemblies in various lengths to extend the reach of your Lamina Drill Head. Don't see the size you need below? Custom length hoses can be manufactured. Contact your Lamina representative for a quotation. Please remember that excessive hose lengths will result in pressure loss and could change the performance of your drill head.

Hose Length	Part #
16 FT.	ASSY-5-74-16FT
20 FT.	ASSY-5-74-20FT
30 FT.	ASSY-5-74-30FT
40 FT.	ASSY-5-74-40FT
50 FT.	ASSY-5-74-50FT
60 FT.	ASSY-5-74-60FT
75 FT.	ASSY-5-74-75FT



### Pendant Control Extension

Extend the reach of your Pendant Control with our Extension Assemblies. This assembly will require some modification to your existing Pendant Cord, to accommodate the use of connectors. Connector Kit (Part # HLDR0000-0221) is also required if your pendant control cable has not been modified to accept an extension cable.

Extension Length	Part #
30 FT.	HLHP0000-0208
50 FT.	HLHP0000-0082
100 FT.	HLHP0000-0083

## Hydraulic Power Unit Replacement Parts

### Pendant Control Assembly

Pendant Length	Part #
30 FT.	LPU99 (standard)
50 FT.	HLHP0000-0021
60 FT.	HLHP0000-0008
75 FT.	LPU99-75FT

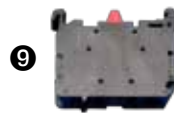
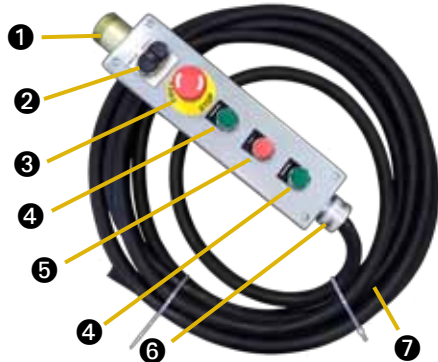

Item	Description	Part #
1	Female Molded Plug	47EL72
2	Increase/Decrease Switch	HLHP0000-0114
3	E-Stop Button	LPU10
4	Forward/Reverse Button	LPU22
5	Stop Button	LPU23
6	Connector/Cord Grip	23EL
7	Pendant Cord (sold per foot, 30 ft. is standard length)	WIRE14-10BLK
8	Normally Open Pendant Contact	LPU94
9	Normally Closed Pendant Contact	LPU95

### Increase- Decrease Switch

Part # 81EL86  
(fits older models)



### Hydraulic Filter

Part # LPU06C



### Back-up Battery

Part # 85EL74  
(60A deep cycle gel cell)



### Replacement Hose Set

Part # ASSY-5-74  
(15 ft. Standard Length)



### Replacement Power Cable

Part # WIRE10-4 BLK  
Sold per foot, (30 ft. standard)



### Hose Connectors

Part # 21HY (female)  
Part # 22HY (male)  
Fits 1/2" diameter hose





## Hydraulic Drill Head Replacement Parts



### Hose Sets

Standard length of hose is 7.5 feet long. Hose extensions appear on the previous page.

Size	Drill Head Series	Part #
1/4"	A10048xx	<b>ASSY-6-74</b>
3/8"	B10065x, B15075xx	<b>ASSY-10-74</b>
1/2"	H15010P-xxxx	<b>ASSY-9-74</b>



### Molded Plug, Cable, & Grip

Molded Plug/  
Cable

Cable Grip

Component	Lamina Drill Series Part #				
	A10048SH	A10048H	B10065H	B10065P	B15075P
Molded Plug/Cable	<b>38C</b>			<b>38E</b>	
Cable Grip	<b>30C</b>			<b>30CL</b>	
	4 Conductor			6 Conductor	

### Safety Shutoff Switch

Fits B10065P, B15075P, and H15010P series drill heads.



Item	Description	Part #
1	Micro Switch Cover	<b>103E</b>
2	Micro Switch	<b>104E</b>
3	Switch Activator	<b>104E-A</b>
4	Micro Rod Spring	<b>106E</b>
5	Micro Rod	<b>107E</b>

### Replacement Hydraulic Motor

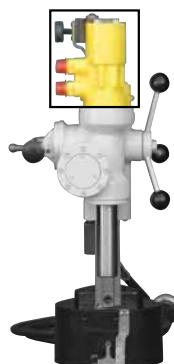

Motor Part #	For Drill Head
<b>A100SH</b>	A10048SH
<b>A100H</b>	A10048H
<b>B100H</b>	B10065H
<b>B100P</b>	B10065P B10065P-OF
<b>B150P</b>	B15075P B15075P-OF
<b>HLDR0000-0098</b>	H15010P H15010P-OF
<b>HLDR0000-0099</b>	H15010P-OM H15010P-OFOM



### Magnet On/Off Switch

Part # 36C  
Fits all models

### Feed Rod and Balls

Fits B10065P, B15075P, and H15010P series drill heads. 3 required per drill head.



### Feed Handle and Hex Key

Fits A10048SH, A10048H, and B10065H drill heads

Description	Part #
Feed Handle	<b>25C</b>
Hex Key	<b>24C</b>

Component	Lamina Drill Part #		
	H15010P	B15075P	B10065P
Feed Rod	<b>60D</b>	<b>60E</b>	<b>60CL</b>
Feed Rod Ball	<b>59D</b>	<b>59E</b>	<b>59CL</b>

# Hydraulic Drill Head Replacement Parts

## Drill Locator Components, All Drill Heads



Item	Component	Lamina Drill Series Part #					
		A10048SH	A10048H	B10065H	B10065P	B15075P	H15010P
1	Drill Locator	20CLH	20CLH	20B	20E	20E	20D
2	Locator Pin	40C	40C	40B	40B	40B	40D
3	Locator Spring	29CLH	29CLH	29E	29E	29E	29E

## Clutch Assembly, Power-Feed Heads Only



Item	Component	Lamina Drill Series Part #		
		B10065P	B15075P	H15010P
	Complete Clutch Assembly (contains all parts below)	HLDR0000-0130	HLDR0000-0129	HLDR0000-0126
1	Clutch Bearing	68CL	68E	68D
2	Feed Clutch Retainer	96CL	96E	96D
3	Feed Cam Handle	97CL	97E	97D
4	Feed Cam Handle Pin	100CL	100E	100D
5	Feed Kick-Off Finger	129CL	129E	129D
6	Feed Kick-Off Rod	130CL	130E	130D
7	Feed Cam Handle Plunger	133CL	133CL	133CL
8	Feed Kick-Off Bushing	135CL	135CL	135CL
9	Rod Spring	137CL	137CL	137CL
10	Plunger Spring	138CL	138CL	138CL
11	10-32 X 1/2 Half Dog Set Screw	139CL	139CL	139CL
12	10-32 Hex Nut Z.P.	140CL	140CL	140CL
13	Knob - 1" OD Knurled W/ 1/4-20	HLDR0000-0100	HLDR0000-0100	HLDR0000-0100
14	Clutch Stop		151D	151D

## Feed Scale Components, Power-Feed Heads Only

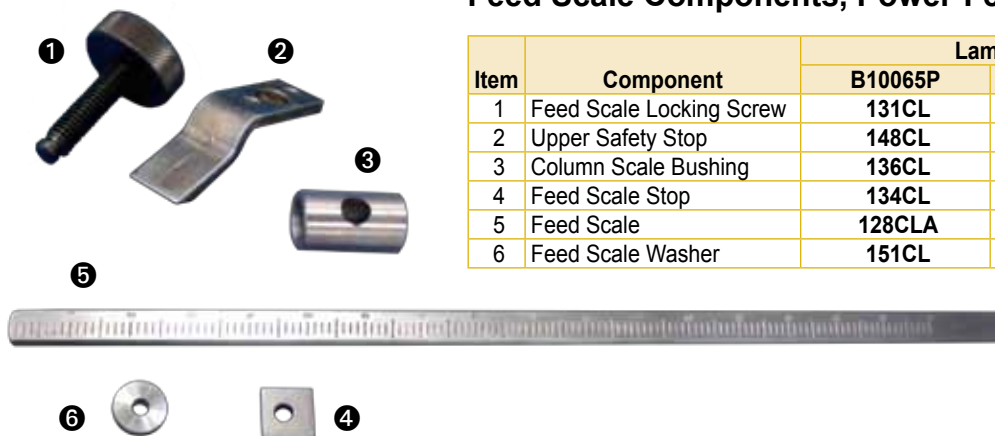

Item	Component	Lamina Drill Series Part #		
		B10065P	B15075P	H15010P
1	Feed Scale Locking Screw	131CL	131CL	131CL
2	Upper Safety Stop	148CL	148CL	148CL
3	Column Scale Bushing	136CL	136CL	136CL
4	Feed Scale Stop	134CL	134CL	134CL
5	Feed Scale	128CLA	128E	128D
6	Feed Scale Washer	151CL	151CL	151CL

## Hydraulic Drill Head Replacement Parts

### Replacement Gears, Power-Feed Heads Only

The worm mechanism sets the feed rate on the Power-feed drill heads. If you do not have an experienced maintenance crew, we recommend you send your drill head back to Lamina for this replacement.

#### B10065P Series



Drill Head	Feed Rate	Spindle	Worm Feed Wheel
B10065P	.005 IN/REV	15CLB-.005	92CL-.005
B10065P-OF	.0025 IN/REV	15CLB.0025-SPEC	92CL-.0025-SPEC

Note: Gearing replacement involves changing the spindle. There is not a separate Feed Worm Shaft.

#### B15075P & H15010P Series



Drill Head	Feed Rate	Feed Worm Shaft	Worm Feed Wheel
B15075P	.0075 IN/REV	91E-.0075	94E-.0075
B15075P-OF	.0037 IN/REV	91E-.0037-SPEC	94E-.0037-SPEC
H15010P	.010 IN/REV	91D-.010	94D-.010
H15010P-OF	.005 IN/REV	91D-.005-SPEC	94D-.005-SPEC
H15010P-OM	.010 IN/REV	91D-.010	94D-.010
H15010P-OFOM	.005 IN/REV	91D-.005-SPEC	94D-.005-SPEC

## Hydraulic Die Setter and Separator Parts

### Hose Reel Components

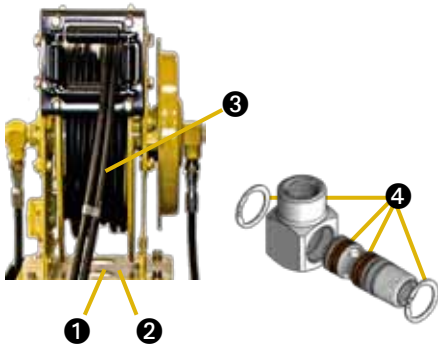

Item	Component	Part #
1	Upper Hose Reel	HLDS0000-0024
2	Lower/Middle Hose Reel	HLDS0000-0023
3	Hose Assembly	ASSY-S-3
4	Reel Seal Kit	HLHP0000-0207

The Reel Seal Kit allows you to rebuild the swivel connector on the reel in case of fluid leaks. Contains: (2) Snap Rings  
(2) O-Rings  
(4) Backup Rings

### Return Filter

Part # EDS146

Fits all EDS and LDS models.



Filter replacement is an important part of the routine maintenance that should be performed to keep your unit working optimally.

### Replacement Pendant Assembly

Part # HLDS0000-0022

Fits all EDS and LDS models.



Older units may have 2 button pendants. These are no longer available and should be converted to this pendant.

### Hydraulic Hose Connectors

Part # DS27 (Female)

DS26 (Male)

Fits all EDS and LDS models with 1/4" hose.



## Hydraulic Equipment Rental Program

Lamina offers a number of different programs to make it easier to purchase, rent or lease to own our hydraulic equipment.

### Rental Program

The Lamina Rental Program is for customers who require the use of its equipment for a short period of time without the commitment of a capital expense. The rental charge is 10% of the current list price per week, with a minimum rental period of two weeks. Billing for the first two weeks rental begins when the equipment is shipped and will continue on a weekly basis until the equipment is returned.

Freight charges are the responsibility of the customer. Lamina will ship "Freight Collect", and the equipment must be shipped back "Prepaid". The shipping and receiving location is Anchor Lamina Inc. 3650 South Derenzy Road, Bellaire, Michigan 49615. The rented equipment must be returned to the Bellaire location.

Damages resulting from abuse of the equipment will be the responsibility of the customer. All components must be returned with the rented equipment. All rental equipment must be returned in the original crating in reusable condition or a charge of \$1000.00 will be invoiced to cover the replacement of new crating.

On occasion, Lamina sells rental equipment. The rental equipment includes a warranty of 90 days. Contact the Lamina Customer Service at 800-652-6462 for availability.

### Rental Credit Program

The Lamina Rental Credit Program is for customers who returned the rental equipment and decided to purchase new equipment. Lamina will apply 50% of the rental fee, up to and including the fourth week of rental, toward the purchase of new equipment. Lamina will reduce the selling price of the new unit by the credit amount. The credit is offered on the same model that is rented and the offer is valid for 30 days after the completion of the rental.

### Rent-To-Own Program

The Lamina Rent-to-Own Program is for customers who want to rent rather than purchase capital equipment. If you rent the equipment for 12 consecutive weeks, you own it. The rental equipment includes a warranty similar to new equipment, except it is for six (6) months. The warranty period starts on the original date of shipment of the hydraulic equipment from Bellaire, Michigan.

## Bring new life to your existing Lamina hydraulic equipment!

Perhaps your power unit isn't running as efficiently as it once did. We can fix that! Your drill head isn't moving up and down the column as smoothly as it should? We can make it like new!

Talk to one of our inside sales representatives and find out how easily we can bring new life to your used Lamina equipment.

Lamina can bring your equipment up to date, add lifting bales to your power unit and even a new coat of paint.

Contact us today!



### Dayton Lamina Corporation

500 Progress Road

Dayton, Ohio 45449

Tel: 248-489-9122, 800-652-6462

Fax: 248-553-6842, 800-406-4410

E-Mail: [sales@lamina.com](mailto:sales@lamina.com)

[www.daytonlamina.com](http://www.daytonlamina.com)

a MISUMI Group Company