

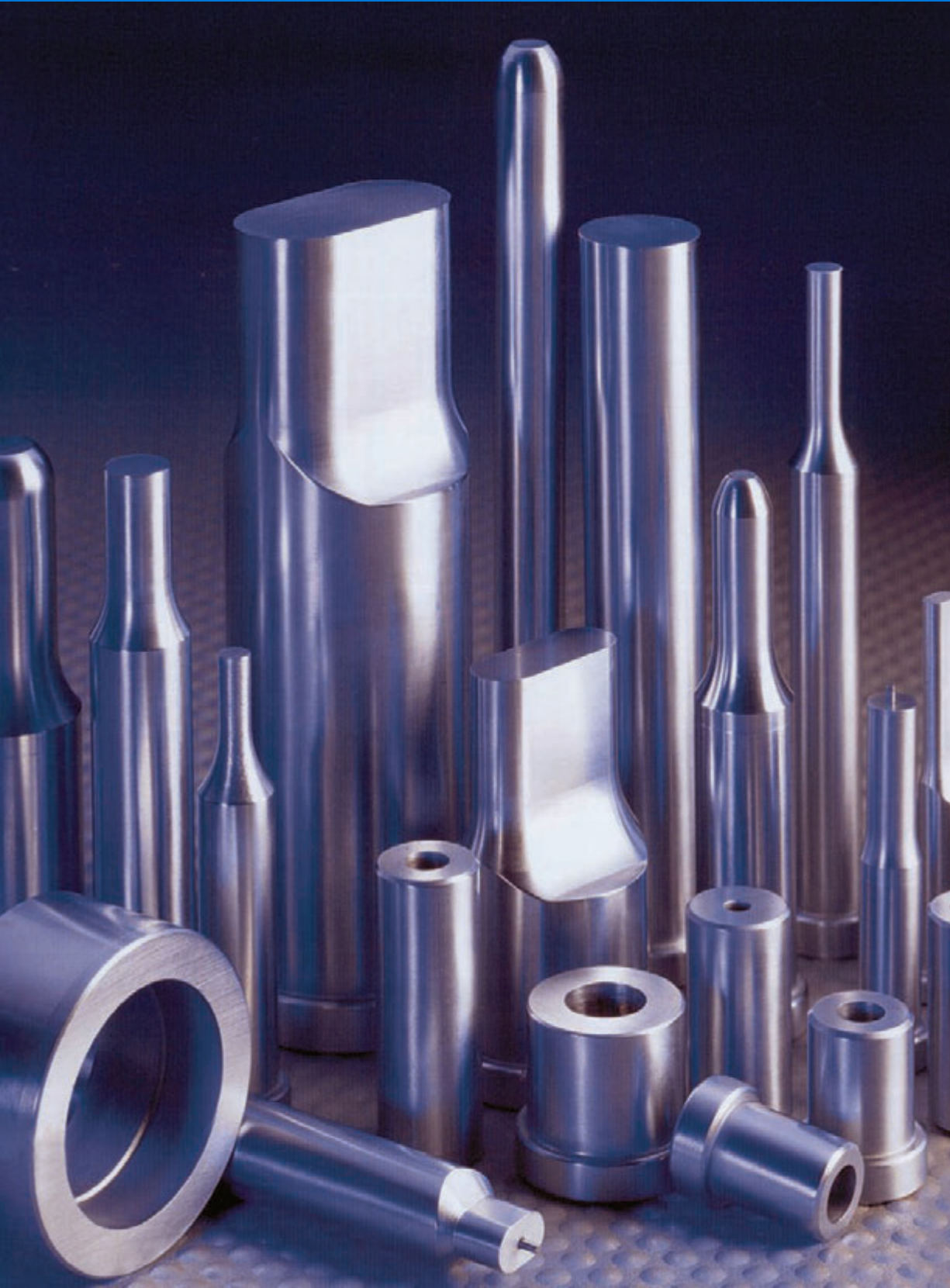

TRUSTED SOLUTIONS AND INNOVATION

BASIC SERIES PUNCHES



RELY ON
ANCHOR DANLY
FOR...

- ◆ QUICK DELIVERY
- ◆ CONSISTENT QUALITY
- ◆ TOTAL CUSTOMER SUPPORT
- ◆ QUICK QUOTES ON SPECIALS

BASIC SERIES PUNCHES

FAST, FLEXIBLE AND FULL SERVICE PUNCH SUPPLIER

Anchor Danly manufactures a full line of standard and custom punch products, die buttons and retainers to high quality standards giving you the reliability and dependable performance you expect. Punches have always been a significant product foundation of our business. Through the years, we have developed expertise in manufacturing a wide range of them.

This catalog features the Anchor Danly Punchrite Basic Series Punches in standard shapes. Designed and manufactured for longer production runs, Anchor Danly Punchrite punches meet or exceed ANSI standards. Products are manufactured to exacting tolerances to assure interchangeability. Each component is made of quality heat treated tool steel. Whether your application is the most simple design or the most complex application, rely on Anchor Danly Punchrite to fit your needs.

Anchor Danly is a leading manufacturer of die sets and die applications, with various locations. With years of experience in the industry, we have gained an in-depth knowledge of metal stamping which we share with our customers.

Punches, Die Buttons and Components

- Full line of standard shapes plus custom products
- Ready availability and fast service
- Technical assistance
- Complies with ANSI standards
- High strength tool steels
- Assured interchangeability
- Consistent craftsmanship













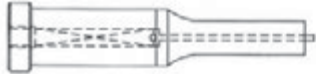











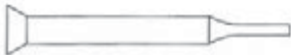

For Standard or Special Punches

In addition to standard and coded shapes, **ANCHOR DANLY** offers special punches, die buttons and other components custom-made to your specifications. Almost any shape can be put on a standard shank. Using **ANCHOR DANLY** components means cost-effective, fast and precise interchangeability.

To enable us to effectively quote your special punch needs, please provide complete specifications and prints where possible.

***FOR FAST QUOTES, DEPENDABLE DELIVERY AND TECHNICAL ASSISTANCE
FOR STANDARDS AND SPECIALS, RELY ON ANCHOR DANLY.***

Basic Series

	PAGE NUMBER		
Perforating Punches	2		
Perforating Ejector Punches	3		
Pilot Punches	4		
"A" Type Pilot Punches	5		
Blank Punches	6		
Ejector Blank Punches	6		
Press Fit Die Buttons – Round	7		
Press Fit Die Buttons – Shapes	8		
Blank Quills	10		
Quill Punches	10		
Quill Retainers	11		
Quill Guides	11		
Quill Buttons	11		
Locking Devices	12		

Perforating Punches



Standard & Medium Point Length

Concentricity: Point to Shank (P:D)
ROUND: .0005 T.I.R. (Max.)
SHAPES: .001 T.I.R. (Max.)

How to order:
Please specify: Quantity, catalog number, overall length, point dimensions, material and, if desired, standard or custom locking device.*

See ordering examples.
NOTE: If material is not specified, M2 will be provided.

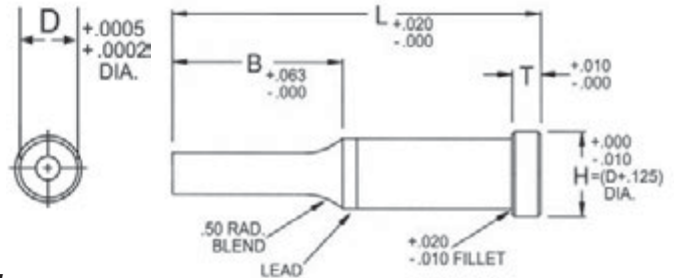

CP, CPM (ROUND)

CP: Standard point length
 CPM: Medium point length

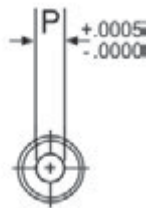

Catalog Number	Shank Diameter	Range of Point Diameter	
CP	CPM	D	P Max.
18	3/16	.062	.186
25	1/4	.062	.249
31	5/16	.093	.311
37	3/8	.125	.374
50	1/2	.187	.499
62	5/8	.375	.624
75	3/4	.500	.749
100	1	.750	.999

The specified P & W dimensions must not result in a shape diagonal greater than G Max. listed in the chart.

EXAMPLE: 6 CP37 L 2.50 P .250 A2

OP, OPM (OBLONG)

OP: Standard point length OPM: Medium point length

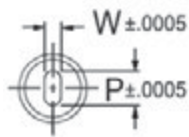

Catalog Number	Shank Diameter	Range of Point Dimensions	
OP	OPM	D	P Max.
18	3/16	.186	.062
25	1/4	.249	.062
31	5/16	.311	.093
37	3/8	.374	.125
50	1/2	.499	.187
62	5/8	.624	.250
75	3/4	.749	.312
100	1	.999	.375

EXAMPLE: 4 OP62 L 2.75 P .500 W .312 M2 SKF

RP, RPM (RECTANGLE, INCLUDES SQUARE)

RP: Standard point length RPM: Medium point length

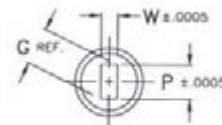

$$G = \sqrt{P^2 + W^2}$$

Catalog Number	Shank Diameter	Range of Point Dimensions	
RP	RPM	D	G Max.
18	3/16	.186	.062
25	1/4	.249	.062
31	5/16	.311	.093
37	3/8	.374	.125
50	1/2	.499	.187
62	5/8	.624	.250
75	3/4	.749	.312
100	1	.999	.375

EXAMPLE: 7 RP50 L 2.50 P .375 W .250 M2

Shank Diameter D	Overall Lengths L									Pt. Length B		Head Dimensions	
	1-1/2	1-3/4	2	2-1/4	2-1/2	2-3/4	3	3-1/2	4	Std.	Med.	H	T
3/16 (.1875)	1.50	1.75	2.00	2.25	2.50	-	-	-	-	7/16	9/16	5/16	1/8
1/4 (.250)	1.50	1.75	2.00	2.25	2.50	-	-	-	-	1/2	5/8	3/8	1/8
5/16 (.3125)	1.50	1.75	2.00	2.25	2.50	2.75	3.00	-	-	9/16	3/4	7/16	1/8
3/8 (.375)	-	1.75	2.00	2.25	2.50	2.75	3.00	-	-	5/8	13/16	1/2	3/16
1/2 (.500)	-	-	2.00	2.25	2.50	2.75	3.00	3.50	-	13/16	1	5/8	3/16
5/8 (.625)	-	-	2.00	2.25	2.50	2.75	3.00	3.50	-	15/16	1-1/8	3/4	1/4
3/4 (.750)	-	-	-	2.25	2.50	2.75	3.00	3.50	4.00	1-1/16	1-1/4	7/8	1/4
1 (1.000)	-	-	-	-	2.50	2.75	3.00	3.50	4.00	1-1/4	1-3/8	1-1/8	1/4

* See page 12 for Locking Device ordering information.



Standard & Medium Point Length

Concentricity: Point to Shank (P:D)
ROUND: .0005 T.I.R. (Max.)
SHAPES: .001 T.I.R. (Max.)

How to order:
Please specify: Quantity, catalog number, overall length, point dimensions, material and, if desired, standard or custom locking device.*

See ordering examples.
NOTE: If material is not specified, M2 will be provided.

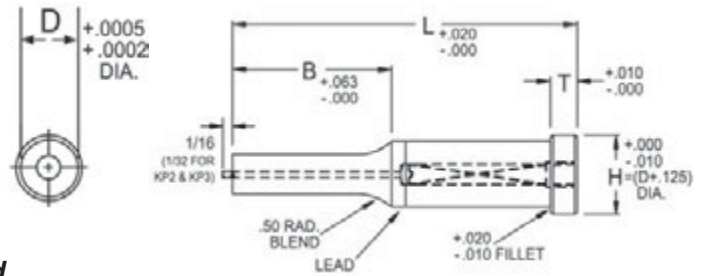

CK, CKM (ROUND)

CK: Standard point length
 CKM: Medium point length

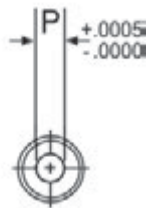

Catalog Number		Shank Diameter	Range of Point Diameter	
CK	CKM	D	P Min.	P Max.
18		3/16	.062	.186
25		1/4	.093	.249
31		5/16	.125	.311
37		3/8	.187	.374
50		1/2	.250	.499
62		5/8	.375	.624
75		3/4	.500	.749
100		1	.750	.999

The specified P & W dimensions must not result in a shape diagonal greater than G Max. listed in the chart.

EXAMPLE: 6 CK37 L 3.00 P .250 M2

OK, OKM (OBLONG)

OK: Standard point length OKM: Medium point length

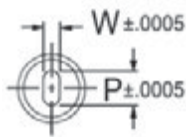

Catalog Number		Shank Diameter	Range of Point Dimensions	
OK	OKM	D	P Max.	W Min.
18		3/16	.186	.062
25		1/4	.249	.093
31		5/16	.311	.125
37		3/8	.374	.187
50		1/2	.499	.187
62		5/8	.624	.250
75		3/4	.749	.312
100		1	.999	.375

EXAMPLE: 6 OK50 L 2.75 P .375 W .187 M2 SKF

RK, RKM (RECTANGLE, INCLUDES SQUARE)

RK: Standard point length RKM: Medium point length

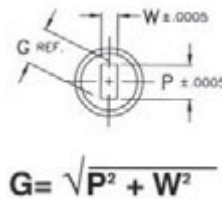

Catalog Number		Shank Diameter	Range of Point Dimensions	
RK	RKM	D	G Max.	W Min.
18		3/16	.186	.062
25		1/4	.249	.093
31		5/16	.311	.125
37		3/8	.374	.187
50		1/2	.499	.187
62		5/8	.624	.250
75		3/4	.749	.312
100		1	.999	.375

EXAMPLE: 7 RK100 L 3.00 P .875 W .375 M2

Shank Diameter D	Overall Lengths L									Pt. Length B		Head Dimensions		Ejector Group Cat.No.
	1-1/2	1-3/4	2	2-1/4	2-1/2	2-3/4	3	3-1/2	4	Std.	Med.	H	T	
3/16 (.1875)	1.50	1.75	2.00	2.25	2.50	—	—	—	—	7/16	9/16	5/16	1/8	KP2**
1/4 (.250)	1.50	1.75	2.00	2.25	2.50	—	—	—	—	1/2	5/8	3/8	1/8	KP3
5/16 (.3125)	1.50	1.75	2.00	2.25	2.50	2.75	3.00	—	—	9/16	3/4	7/16	1/8	KP4
3/8 (.375)	—	1.75	2.00	2.25	2.50	2.75	3.00	—	—	5/8	13/16	1/2	3/16	KP6
1/2 (.500)	—	—	2.00	2.25	2.50	2.75	3.00	3.50	—	13/16	1	5/8	3/16	KP6
5/8 (.625)	—	—	2.00	2.25	2.50	2.75	3.00	3.50	—	15/16	1-1/8	3/4	1/4	KP9
3/4 (.750)	—	—	—	2.25	2.50	2.75	3.00	3.50	4.00	1-1/16	1-1/4	7/8	1/4	KP9
1 (1.000)	—	—	—	—	2.50	2.75	3.00	3.50	4.00	1-1/4	1-3/8	1-1/8	1/4	KP9

* See page 12 for Locking Device ordering information.

** KP23 where min. point dim. is more than .092.

Pilot Punches



Standard & Medium Point Length

Concentricity: Point to Shank (P:D): .0005 T.I.R. (Max.)

How to order:

Please specify: Quantity, catalog number, nominal length, point diameter and material.

See ordering examples.

NOTE: If material is not specified, M2 will be provided.

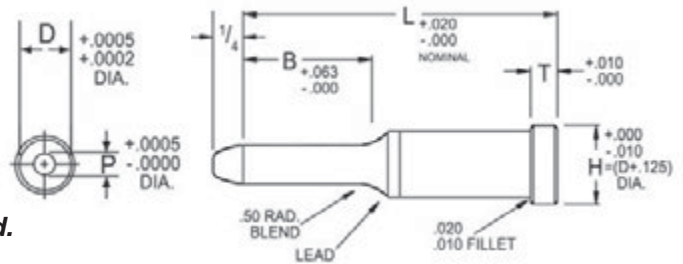

PP (STANDARD POINT LENGTH)

PPM (MEDIUM POINT LENGTH)

Catalog Number	Shank Diameter	Range of Point Diameter		Point Length
		P Min.	P Max.	
	D			B
PP18	3/16	.092	.1875	7/16
PP25	1/4	.092	.250	1/2
PP31	5/16	.092	.3125	9/16
PP37	3/8	.124	.375	5/8
PP50	1/2	.186	.500	13/16
PP62	5/8	.374	.625	15/16
PP75	3/4	.499	.750	1-1/16
PP100	1	.749	1.000	1-1/4

EXAMPLE: 6 PP37 L 2.75 P .249 A2

Catalog Number	Shank Diameter	Range of Point Diameter		Point Length
		P Min.	P Max.	
	D			B
PPM18	3/16	.092	.1875	9/16
PPM25	1/4	.092	.250	5/8
PPM31	5/16	.092	.3125	3/4
PPM37	3/8	.124	.375	13/16
PPM50	1/2	.186	.500	1
PPM62	5/8	.374	.625	1-1/8
PPM75	3/4	.499	.750	1-1/4
PPM100	1	.749	1.000	1-3/8

EXAMPLE: 4 PPM31 L 2.50 P .186 A2

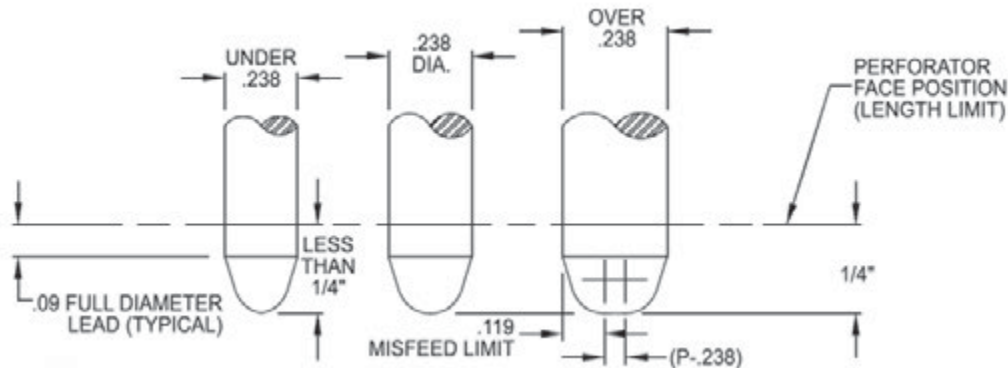

Shank Diameter	Nominal Lengths L										Head Dimensions	
	D	1-1/2	1-3/4	2	2-1/4	2-1/2	2-3/4	3	3-1/2	4	H	T
3/16 (.1875)	1.50	1.75	2.00	2.25	2.50	-	-	-	-	5/16	1/8	
1/4 (.250)	1.50	1.75	2.00	2.25	2.50	-	-	-	-	3/8	1/8	
5/16 (.3125)	1.50	1.75	2.00	2.25	2.50	2.75	3.00	-	-	7/16	1/8	
3/8 (.375)	-	1.75	2.00	2.25	2.50	2.75	3.00	-	-	1/2	3/16	
1/2 (.500)	-	-	2.00	2.25	2.50	2.75	3.00	3.50	-	5/8	3/16	
5/8 (.625)	-	-	2.00	2.25	2.50	2.75	3.00	3.50	-	3/4	1/4	
3/4 (.750)	-	-	-	2.25	2.50	2.75	3.00	3.50	4.00	7/8	1/4	
1 (1.000)	-	-	-	-	2.50	2.75	3.00	3.50	4.00	1-1/8	1/4	

“A” Type

Concentricity: Point to Shank (P:D): .0005 T.I.R. (Max.)

How to order:

Please specify: Quantity, catalog number, nominal length, point diameter and material.

See ordering examples.

NOTE: If material is not specified, M2 will be provided.

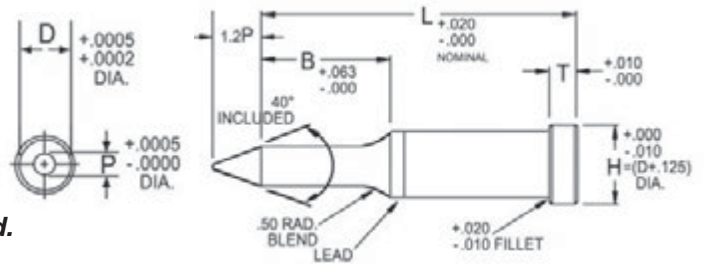

PPA

Catalog Number	Shank Diameter	Range of Point Diameter		Point Length
		P Min.	P Max.	B
PPA37	3/8	.186	.375	5/8
PPA50	1/2	.249	.500	13/16
PPA62	5/8	.311	.625	15/16
PPA75	3/4	.436	.750	1-1/16
PPA100	1	.749	1.000	1-1/4

EXAMPLE: 6 PPA37 L 2.75 P .249 A2

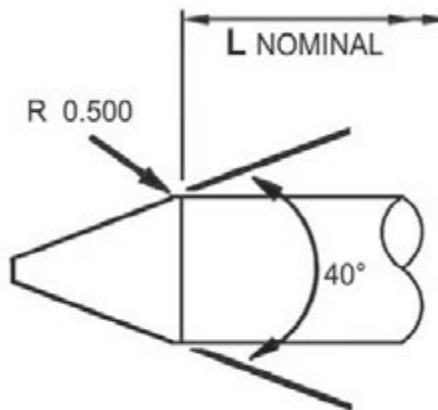

NOTE: Under .186 Point Diameter Pilot Nose is 1.5P

Shank Diameter	Nominal Lengths L											Head Dimensions	
	D	2-1/2	2-3/4	3	3-1/4	3-1/2	3-3/4	4	4-1/4	4-1/2	4-3/4	H	T
3/8 (.375)	2.50	2.75	3.00	3.25	3.50	3.75	4.00	–	–	–	1/2	3/16	
1/2 (.500)	2.50	2.75	3.00	3.25	3.50	3.75	4.00	4.25	4.50	4.75	5/8	3/16	
5/8 (.625)	2.50	2.75	3.00	3.25	3.50	3.75	4.00	4.25	4.50	4.75	3/4	1/4	
3/4 (.750)	2.50	2.75	3.00	3.25	3.50	3.75	4.00	4.25	4.50	4.75	7/8	1/4	
1 (1.000)	–	–	3.00	3.25	3.50	3.75	4.00	4.25	4.50	4.75	1-1/8	1/4	

Blank & Ejector Blank Punches



Head Type

How to order:

Please specify: Quantity, catalog number, overall length and material.

See ordering examples.

NOTE: If material is not specified, M2 will be provided.

BP (BLANK)

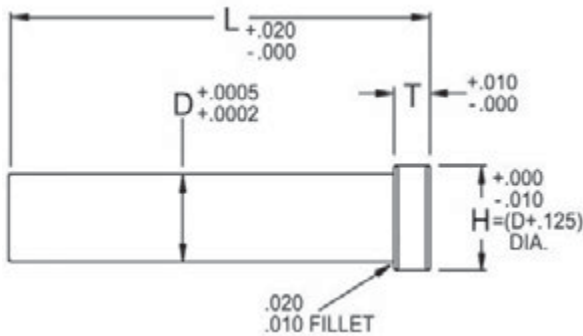

Catalog Number	Shank Diameter
	D
BP18	3/16
BP25	1/4
BP31	5/16
BP37	3/8
BP50	1/2
BP62	5/8
BP75	3/4
BP100	1

EXAMPLE: 8 BP25 L 2.00 A2

BK (EJECTOR BLANK)

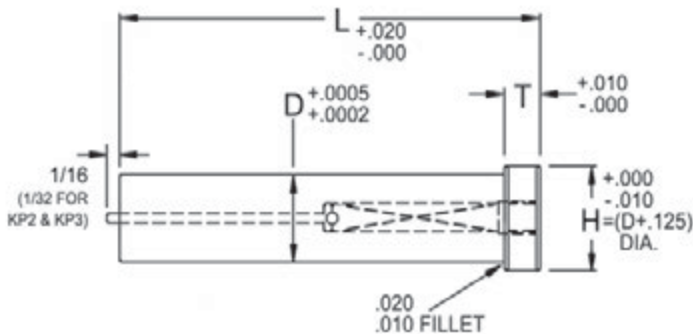

Catalog Number	Shank Diameter	Ejector Grp.
	D	Cat. No.
BK18	3/16	KP2, KP 23
BK25	1/4	KP3
BK31	5/16	KP43
BK37	3/8	KP6
BK50	1/2	KP6
BK62	5/8	KP9
BK75	3/4	KP9
BK100	1	KP9

EXAMPLE: 5 BK37 L 2.50 M2

Shank Diameter D	Overall Lengths L									Head Dim.	
	1-1/2	1-3/4	2	2-1/4	2-1/2	2-3/4	3	3-1/2	4	H	T
3/16 (.1875)	1.50	1.75	2.00	2.25	2.50	–	–	–	–	5/16	1/8
1/4 (.250)	1.50	1.75	2.00	2.25	2.50	–	–	–	–	3/8	1/8
5/16 (.3125)	1.50	1.75	2.00	2.25	2.50	2.75	3.00	–	–	7/16	1/8
3/8 (.375)	–	1.75	2.00	2.25	2.50	2.75	3.00	–	–	1/2	3/16
1/2 (.500)	–	–	2.00	2.25	2.50	2.75	3.00	3.50	–	5/8	3/16
5/8 (.625)	–	–	2.00	2.25	2.50	2.75	3.00	3.50	–	3/4	1/4
3/4 (.750)	–	–	–	2.25	2.50	2.75	3.00	3.50	4.00	7/8	1/4
1 (1.000)	–	–	–	–	2.50	2.75	3.00	3.50	4.00	1-1/8	1/4

Round

Concentricity: Hole to Body (P:D): .0005 T.I.R. (Max.)

How to order:

Please specify: Quantity, catalog number, overall length, die hole diameter and material.

See ordering examples.

NOTE: If material is not specified, A2 will be provided.

CD (HEADLESS)

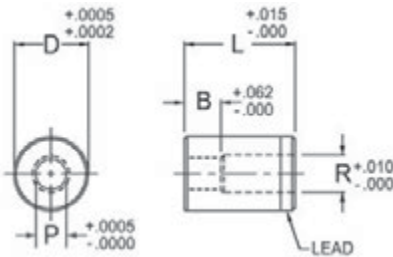

Catalog Number	Body Diameter D	Range of Hole Dia.		Overall Lengths L					
		P Min.	P Max.	3/4	7/8	15/16	1	1-1/8	1-1/4
CD25	1/4 (.250)	.064	.125	.750	.875	.937	1.000	1.125	1.250
CD37	3/8 (.375)	.064	.195	.750	.875	.937	1.000	1.125	1.250
CD50	1/2 (.500)	.126	.285	.750	.875	.937	1.000	1.125	1.250
CD62	5/8 (.625)	.196	.345	.750	.875	.937	1.000	1.125	1.250
CD75	3/4 (.750)	.286	.435	.750	.875	.937	1.000	1.125	1.250
CD87	7/8 (.875)	.346	.545	.750	.875	.937	1.000	1.125	1.250
CD100	1 (1.000)	.436	.655	.750	.875	.937	1.000	1.125	1.250
CD125	1-1/4 (1.250)	.546	.780	.750	.875	.937	1.000	1.125	1.250
CD150	1-1/2 (1.500)	.656	1.035	.750	.875	.937	1.000	1.125	1.250

EXAMPLE: 8 CD50 L 1.00 P .281 A2

CH (HEADED)

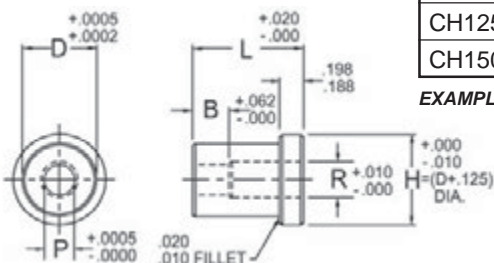

Catalog Number	Body Diameter D	Range of Hole Dia.		Overall Lengths L					Head Dia. H
		P Min.	P Max.	3/4	7/8	1	1-1/8	1-1/4	
CH25	1/4 (.250)	.064	.125	.750	.875	1.000	1.125	1.250	3/8
CH37	3/8 (.375)	.064	.195	.750	.875	1.000	1.125	1.250	1/2
CH50	1/2 (.500)	.126	.285	.750	.875	1.000	1.125	1.250	5/8
CH62	5/8 (.625)	.196	.345	.750	.875	1.000	1.125	1.250	3/4
CH75	3/4 (.750)	.286	.435	.750	.875	1.000	1.125	1.250	7/8
CH87	7/8 (.875)	.346	.545	.750	.875	1.000	1.125	1.250	1
CH100	1 (1.000)	.436	.655	.750	.875	1.000	1.125	1.250	1-1/8
CH125	1-1/4 (1.250)	.546	.780	.750	.875	1.000	1.125	1.250	1-3/8
CH150	1-1/2 (1.500)	.656	1.035	.750	.875	1.000	1.125	1.250	1-5/8

EXAMPLE: 5 CH75 L 1.125 P .381 A2

Shapes

Concentricity: Hole to Body (P:D): .001 T.I.R. (Max.)

How to order:

Please specify: Quantity, catalog number, overall length, die hole dimensions, material and, if desired, standard or custom locking device.*

See ordering examples.

NOTE: If material is not specified, A2 will be provided.

OD (OBLONG), RD (RECTANGLE, INCLUDES SQUARE) – HEADLESS

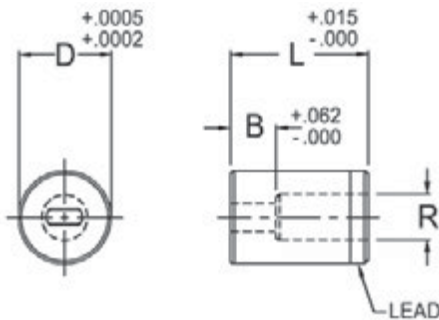

Body Diameter D	Overall Lengths L					
	3/4	7/8	15/16	1	1-1/8	1-1/4
3/8 (.375)	.750	.875	.937	1.000	1.125	1.250
1/2 (.500)	.750	.875	.937	1.000	1.125	1.250
5/8 (.625)	.750	.875	.937	1.000	1.125	1.250
3/4 (.750)	.750	.875	.937	1.000	1.125	1.250
7/8 (.875)	.750	.875	.937	1.000	1.125	1.250
1 (1.000)	.750	.875	.937	1.000	1.125	1.250
1-1/4 (1.250)	.750	.875	.937	1.000	1.125	1.250
1-1/2 (1.500)	.750	.875	.937	1.000	1.125	1.250

EXAMPLE: 6 OD50 L 1.125 P .284 W .144 A2 SKF

OH (OBLONG), RH (RECTANGLE, INCLUDES SQUARE) – HEADED

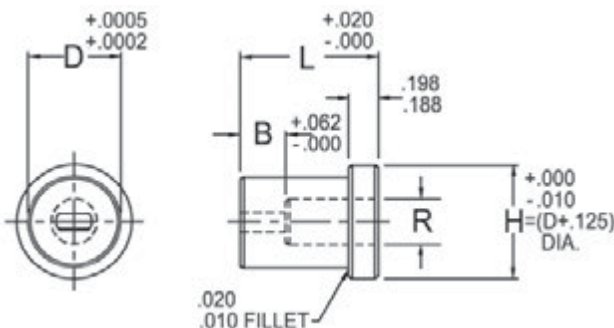

Body Diameter D	Overall Lengths L					Head Dia. H
	3/4	7/8	1	1-1/8	1-1/4	
3/8 (.375)	.750	.875	1.000	1.125	1.250	1/2
1/2 (.500)	.750	.875	1.000	1.125	1.250	5/8
5/8 (.625)	.750	.875	1.000	1.125	1.250	3/4
3/4 (.750)	.750	.875	1.000	1.125	1.250	7/8
7/8 (.875)	.750	.875	1.000	1.125	1.250	1
1 (1.000)	.750	.875	1.000	1.125	1.250	1-1/8
1-1/4 (1.250)	.750	.875	1.000	1.125	1.250	1-3/8
1-1/2 (1.500)	.750	.875	1.000	1.125	1.250	1-5/8

EXAMPLE: 5 OH62 L 1.125 P .284 W .144 A2 SKF

Hole Size Information

OD, OH (OBLONG)

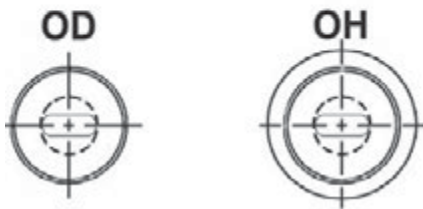
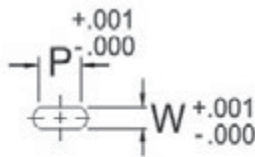

Body Dia.	Catalog Numbers		Range of Hole Sizes		Relief Hole	Land Length	
	D	OD	OH	P Max.	W Min.	R Max.	B
3/8		37		.195	.048	.238	3/16
1/2		50		.285	.064	.322	1/4
5/8		62		.345	.095	.385	1/4
3/4		75		.435	.127	.478	1/4
7/8		87		.545	.158	.588	5/16
1		100		.655	.189	.697	3/8
1-1/4		125		.780	.220	.822	3/8
1-1/2		150		1.035	.252	1.072	7/16

RD, RH (RECTANGLE, INCLUDES SQUARE)

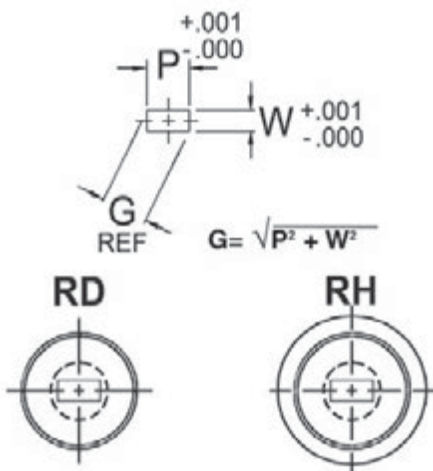

Body Dia.	Catalog Numbers		Range of Hole Sizes		Relief Hole	Land Length	
	D	RD	RH	G Max.	W Min.	R Max.	B
3/8		37		.195	.048	.238	3/16
1/2		50		.285	.064	.322	1/4
5/8		62		.345	.095	.385	1/4
3/4		75		.435	.127	.478	1/4
7/8		87		.545	.158	.588	5/16
1		100		.655	.189	.697	3/8
1-1/4		125		.780	.220	.822	3/8
1-1/2		150		1.035	.252	1.072	7/16

The specified P&W dimensions must not result in a shape diagonal greater than G MAX. listed in the chart.

Angle Head Type

How to order:

Please specify: Quantity, catalog number, overall length and quill diameter or point size.

See ordering examples.

NOTE: If material is not specified, M2 will be provided.

BQ (BLANK QUILL)

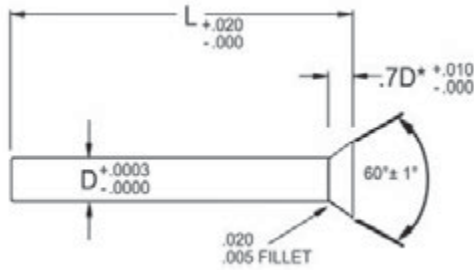

Catalog Number	Quill Diameter .001 Increments		Overall Length L	
	D Min.	D Max.	2	2-1/2
BQ06	.030	.0625	2.00	2.50
BQ09	.063	.0938	2.00	2.50
BQ12	.095	.1250	2.00	2.50
BQ15	.126	.1562	2.00	2.50
BQ18	.157	.1875	2.00	2.50
BQ21	.188	.2188	2.00	2.50
BQ25	.220	.2500	2.00	2.50

EXAMPLE: 6 BQ12 L 2.50 D .101 M2

* For .224" diameter and up, the dimension is 5/32" max.

QP (QUILL PUNCH)

Catalog Number	Shank Diameter D	Point Size		Overall Lengths L					Point Length B
		P Min.	P Max.	1-1/2	1-3/4	2	2-1/4	2-1/2	
QP06	.0625	.030	.062	1.50	1.75	2.00	2.25	2.50	3/16
QP09	.0938	.050	.093	1.50	1.75	2.00	2.25	2.50	1/4
QP12	.1250	.080	.124	1.50	1.75	2.00	2.25	2.50	5/16
QP15	.1562	.110	.156	1.50	1.75	2.00	2.25	2.50	5/16
QP18	.1875	.140	.187	1.50	1.75	2.00	2.25	2.50	5/16
QP21	.2188	.170	.218	1.50	1.75	2.00	2.25	2.50	5/16
QP25	.2500	.200	.249	1.50	1.75	2.00	2.25	2.50	5/16

EXAMPLE: 6 QP12 L 2.00 P .120 M2

* For .224" diameter and up, the dimension is 5/32" max.

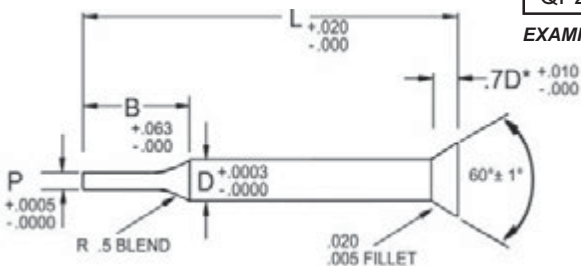



Basic Head Type

How to order:

Please specify: Quantity, catalog number, overall length and hole size.

See ordering examples.

NOTE: If material is not specified, A2 will be provided.

QR (QUILL RETAINER)

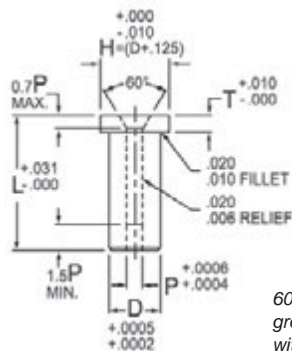

60° angle and hole P ground concentric to within .0003 T.I.R.

Catalog Number	Body Diameter		Hole Diam.	Overall Lengths L			Head Sizes	
	D	P		3/4	1	1-1/4	H	T
QR18	3/16	(.1875)	.0625	.75	1.00	1.25	5/16	1/8
QR25	1/4	(.250)	.0938	.75	1.00	1.25	3/8	1/8
QR31	5/16	(.3125)	.1250	.75	1.00	1.25	7/16	1/8
QR37	3/8	(.375)	.1562	.75	1.00	1.25	1/2	3/16
QR43	7/16	(.4375)	.1875	.75	1.00	1.25	9/16	3/16
QR50	1/2	(.500)	.2188	.75	1.00	1.25	5/8	3/16
QR62	5/8	(.625)	.2500	.75	1.00	1.25	3/4	1/4

QG (QUILL GUIDE)

EXAMPLE: 6 QR50 L 1.00 A2

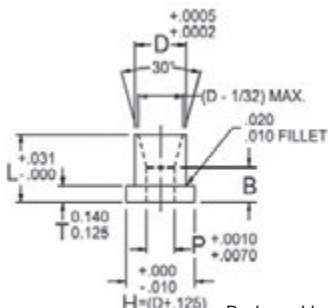

Body and hole ground concentric to within .0003 T.I.R.

Catalog Number	Body Diameter		Hole Diam.	Overall Lengths L			Head Sizes			Land
	D	P		1/2	5/8	3/4	H	T	B	
QG18	3/16	(.1875)	.0625	.50	-	-	5/16	1/8	3/8	
QG25	1/4	(.250)	.0938	-	.62	-	3/8	1/8	1/2	
QG31	5/16	(.3125)	.1250	-	-	.75	7/16	1/8	5/8	
QG37	3/8	(.375)	.1562	-	-	.75	1/2	1/8	5/8	
QG43	7/16	(.4375)	.1875	-	-	.75	9/16	1/8	5/8	
QG50	1/2	(.500)	.2188	-	-	.75	5/8	1/8	5/8	
QG62	5/8	(.625)	.2500	-	-	.75	3/4	1/8	5/8	

QD (QUILL BUTTON)

EXAMPLE: 6 QG50 A2

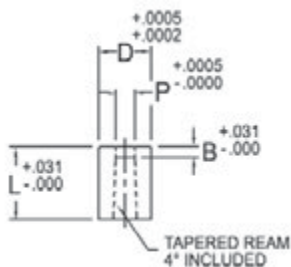

Body and hole ground concentric to within .0005 T.I.R.

Catalog Number	Body Diameter		Hole Diam.		Overall Length L	Land B
	D	P	P Min.	P Max.		
QD12	1/8	(.125)	.031	.046	.37	1/32
QD18	3/16	(.1875)	.031	.062	.37	1/32

EXAMPLE: 6 QD18 P .032 A2

Custom and Standard Locations

How to order Custom Location:

Please specify: Type, angle (Y) and depth (M).

Example:

OKM37 L 2.25 P .313 W .188 M2 SKF Y 45° M .156

How to order Standard Location:

Please specify: Type.

Example:

OKM37 L 2.25 P .313 W .188 M2 SKF

CUSTOM

Shape orientation, key flat and dowel slot depth to be specified by the customer.

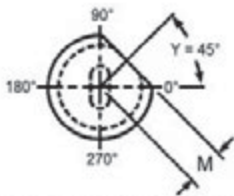

NON-STANDARD LOCATION OR DEPTH



SINGLE KEY FLAT (SKF)

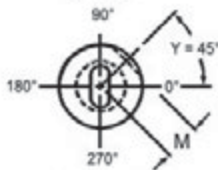

NON-STANDARD LOCATION OR DEPTH

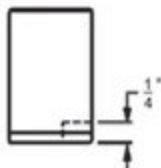

NOTE:
PUNCHES VIEWED THROUGH THE SHANK

STANDARD

Shape orientation is established by the polar positions shown below, at 0°. Standard key flat and dowel slot depth is as shown.

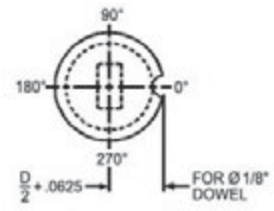
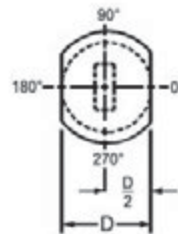
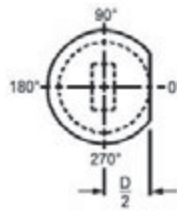

SINGLE KEY FLAT (SKF)

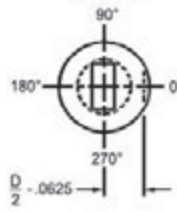

DOUBLE KEY FLAT (DKF)

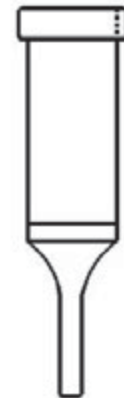
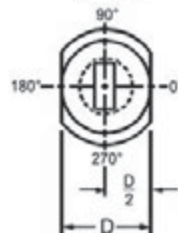

DOWEL SLOT (DS)

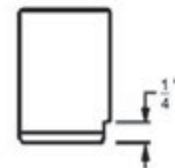
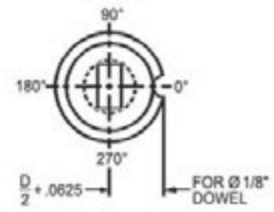

NOTE:
PUNCHES VIEWED THROUGH THE SHANK

Punchrite®

Quality you can rely on



Anchor Danly

6779 Engle Road, Suite A-F
Cleveland, OH 44130

CALL: 800-232-6592
FAX: 800-432-6594

www.anchoranly.com
punchproducts@anchoranly.com