



TRUSTED SOLUTIONS AND INNOVATION

BALL LOCK SERIES PUNCHES



RELY ON
ANCHOR DANLY
FOR...

- ◆ QUICK DELIVERY
- ◆ CONSISTENT QUALITY
- ◆ TOTAL CUSTOMER SUPPORT
- ◆ QUICK QUOTES ON SPECIALS

BALL LOCK SERIES

FAST, FLEXIBLE AND FULL SERVICE PUNCH SUPPLIER

Anchor Danly manufactures a full line of standard and custom punch products, die buttons and retainers to high quality standards giving you the reliability and dependable performance you expect. Punches have always been a significant product foundation of our business. Through the years, we have developed expertise in manufacturing a wide range of them.

This catalog features the Anchor Danly Punchrite Ball Lock Punch Series in standard shapes. Designed and manufactured for longer production runs, Anchor Danly Punchrite punches meet or exceed ANSI standards. Products are manufactured to exacting tolerances to assure interchangeability. Each component is made of quality heat treated tool steel. Whether your application is the most simple design or the most complex application, rely on Anchor Danly Punchrite to fit your needs.

Anchor Danly is a leading manufacturer of die sets and die applications, with various locations. With years of experience in the industry, we have gained an in-depth knowledge of metal stamping which we share with our customers.

Punches, Die Buttons and Components

- Full line of standard shapes plus custom products
- Ready availability and fast service
- Technical assistance
- Complies with ANSI standards
- High strength tool steels
- Assured interchangeability
- Consistent craftsmanship



















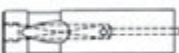













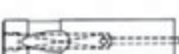

For Standard or Special Punches

In addition to standard and coded shapes, **ANCHOR DANLY** offers special punches, die buttons and other components custom-made to your specifications. Almost any shape can be put on a standard shank. Using **ANCHOR DANLY** components means cost-effective, fast and precise interchangeability.

To enable us to effectively quote your special punch needs, please provide complete specifications and prints where possible.

***FOR FAST QUOTES, DEPENDABLE DELIVERY AND TECHNICAL ASSISTANCE
FOR STANDARDS AND SPECIALS, RELY ON ANCHOR DANLY.***

Ball Lock Series

	PAGE NUMBER		
LIGHT DUTY			
Perforating Punches	2		
Perforating Ejector Punches	3		
Pilot Punches	4		
Blank Punches	4		
Blank Ejector Punches	4		
"A" Type Pilot Punches	5		
Die Buttons	6		
HEAVY DUTY			
Perforating Punches	7		
Perforating Ejector Punches	8		
Pilot Punches	9		
Blank Punches	9		
Blank Ejector Punches	9		
"A" Type Pilot Punches	10		
KNOB PUNCHES			
Knob Punches – Light Duty	11		
Ejector Knob Punches – Light Duty	12		
Knob Punches – Heavy Duty	13		
Ejector Knob Punches – Heavy Duty	14		
RETAINERS			
Ball Lock Retainers – Light Duty	15		
Ball Lock Retainers – Heavy Duty	16		

Perforating Punches



Light Duty

Material: A2 – 5% Chrome; M2 – High Speed Steel

Hardness: Point and Shank Rc 60-63

Concentricity: Point to Shank (P:D)

ROUND: .0005 T.I.R. (Max.)

SHAPES: .0010 T.I.R. (Max.)

How to order:

Please specify: Quantity, catalog number, overall length, point dimensions and material.

See ordering examples.

NOTE: If material is not specified, M2 will be provided.

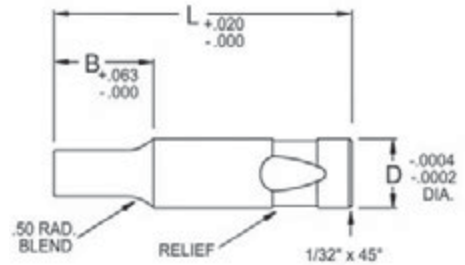

LBCP (ROUND)

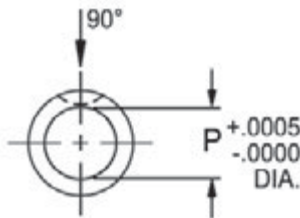

Standard ball seat location shown (↓).
Ball seat location other than standard must be specified.

Catalog Number	Shank Diameter	Range of Point Diameter	
		P Min.	P Max.
LBCP25	1/4	.062	.249
LBCP37	3/8	.125	.374
LBCP50	1/2	.187	.499
LBCP62	5/8	.375	.624
LBCP75	3/4	.500	.749
LBCP87	7/8	.625	.874
LBCP100	1	.750	.999

EXAMPLE: 6 LBCP37 L 2.50 P .250 A2

The specified P & W dimensions must not result in a shape diagonal greater than G Max. listed in the chart.

LBOP (OBLONG)

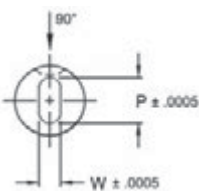

Catalog Number	Shank Diameter	Range of Point Dimensions	
		P Max.	W Min.
LBOP25	1/4	.249	.062
LBOP37	3/8	.374	.125
LBOP50	1/2	.499	.187
LBOP62	5/8	.624	.250
LBOP75	3/4	.749	.312
LBOP87	7/8	.874	.375
LBOP100	1	.999	.437

EXAMPLE: 8 LBOP62 L 3.00 P .606 W .303 A2

LBRP (RECTANGLE, INCLUDES SQUARE)

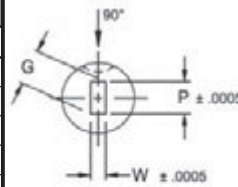

$$G = \sqrt{P^2 + W^2}$$

Catalog Number	Shank Diameter	Range of Point Dimensions	
		G Max.	W Min.
LBRP25	1/4	.249	.062
LBRP37	3/8	.374	.125
LBRP50	1/2	.499	.187
LBRP62	5/8	.624	.250
LBRP75	3/4	.749	.312
LBRP87	7/8	.874	.375
LBRP100	1	.999	.437

EXAMPLE: 4 LBRP50 L 2.50 P .375 W .187 M2

Shank Diameter	Overall Lengths L								Point Length
	D	2	2-1/4	2-1/2	2-3/4	3	3-1/2	4	
1/4 (.250)	2.00	2.25	2.50	2.75	3.00	–	–	–	1/2
3/8 (.375)	2.00	2.25	2.50	2.75	3.00	3.50	–	–	5/8
1/2 (.500)	2.00	2.25	2.50	2.75	3.00	3.50	4.00	–	3/4
5/8 (.625)	2.00	2.25	2.50	2.75	3.00	3.50	4.00	–	7/8
3/4 (.750)	2.00	2.25	2.50	2.75	3.00	3.50	4.00	–	15/16
7/8 (.875)	2.00	2.25	2.50	2.75	3.00	3.50	4.00	–	15/16
1 (1.000)	2.00	2.25	2.50	2.75	3.00	3.50	4.00	–	15/16

Light Duty

Material: A2 – 5% Chrome; M2 – High Speed Steel

Hardness: Point and Shank Rc 60-63

Concentricity: Point to Shank (P:D)

ROUND: .0005 T.I.R. (Max.)

SHAPES: .0010 T.I.R. (Max.)

How to order:

Please specify: Quantity, catalog number, overall length, point dimensions and material.

See ordering examples.

NOTE: If material is not specified, M2 will be provided.

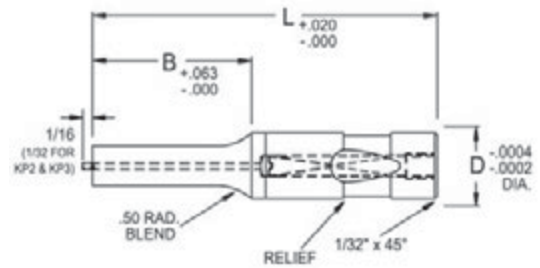

LBCK (ROUND)

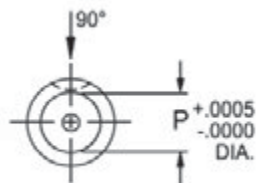

Standard ball seat location shown (↘).
Ball seat location other than standard must be specified.

Catalog Number	Shank Diameter	Range of Point Diameter	
		P Min.	P Max.
LBCK25	1/4	.062	.249
LBCK37	3/8	.125	.374
LBCK50	1/2	.250	.499
LBCK62	5/8	.375	.624
LBCK75	3/4	.500	.749
LBCK87	7/8	.625	.874
LBCK100	1	.750	.999

EXAMPLE: 5 LBCK37 L 2.25 P .127 M2

The specified P & W dimensions must not result in a shape diagonal greater than G Max. listed in the chart.

LBOK (OBLONG)

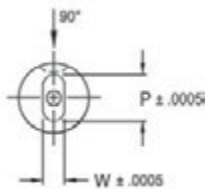

Catalog Number	Shank Diameter	Range of Point Dimensions	
		P Max.	W Min.
LBOK25	1/4	.249	.062
LBOK37	3/8	.374	.125
LBOK50	1/2	.499	.187
LBOK62	5/8	.624	.250
LBOK75	3/4	.749	.312
LBOK87	7/8	.874	.375
LBOK100	1	.999	.437

EXAMPLE: 3 LBOK25 L 2.25 P .188 W .094 M2

LBOK (RECTANGLE, INCLUDES SQUARE)

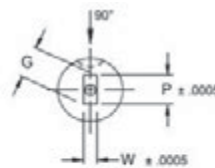

$$G = \sqrt{P^2 + W^2}$$

Catalog Number	Shank Diameter	Range of Point Dimensions	
		G Max.	W Min.
LBOK25	1/4	.249	.062
LBOK37	3/8	.374	.125
LBOK50	1/2	.499	.187
LBOK62	5/8	.624	.250
LBOK75	3/4	.749	.312
LBOK87	7/8	.874	.375
LBOK100	1	.999	.437

EXAMPLE: 9 LBOK50 L 2.50 P .372 W .187 M2

Shank Diameter	Overall Lengths L							Pt. Length	Ejector Grp.
	2	2-1/4	2-1/2	2-3/4	3	3-1/2	4		
D	2	2-1/4	2-1/2	2-3/4	3	3-1/2	4	B	Cat.No.
1/4 (.250)	2.00	2.25	2.50	2.75	3.00	—	—	1/2	KP2*
3/8 (.375)	2.00	2.25	2.50	2.75	3.00	3.50	—	5/8	KP4
1/2 (.500)	2.00	2.25	2.50	2.75	3.00	3.50	4.00	3/4	KP6
5/8 (.625)	2.00	2.25	2.50	2.75	3.00	3.50	4.00	7/8	KP6
3/4 (.750)	2.00	2.25	2.50	2.75	3.00	3.50	4.00	15/16	KP9
7/8 (.875)	2.00	2.25	2.50	2.75	3.00	3.50	4.00	15/16	KP9
1 (1.000)	2.00	2.25	2.50	2.75	3.00	3.50	4.00	15/16	KP9

* KP23 where min. point dim. is more than .092.

Ejector components and design data are shown in the Misc. Products Section.

Pilots, Blanks and Ejector Blank Punches



Light Duty

Material: A2 – 5% Chrome; M2 – High Speed Steel

Hardness: Rc 60-63

Concentricity: Point to Shank (P:D) .0005 T.I.R. (Max.)

How to order:

Please specify: Quantity, catalog number, overall length, (point diameter & nominal length for Pilots) and material.

See ordering examples.

NOTE: If material is not specified, M2 will be provided.

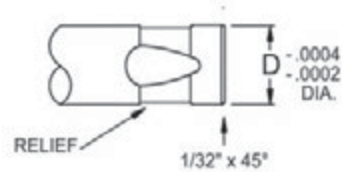

LBPP (PILOT)

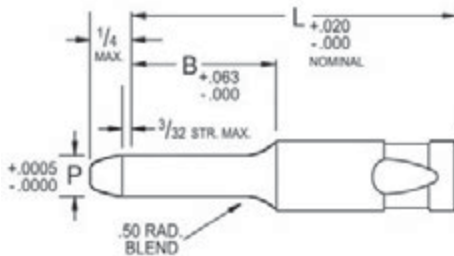

Catalog Number	Shank Diameter	Range of Point Diameter		Point Length
		P Min.	P Max.	
LBPP25	1/4	.092	.249	1/2
LBPP37	3/8	.124	.374	5/8
LBPP50	1/2	.186	.499	3/4
LBPP62	5/8	.374	.624	7/8
LBPP75	3/4	.499	.749	15/16
LBPP87	7/8	.624	.874	15/16
LBPP100	1	.749	.999	15/16

EXAMPLE: 6 LBPP75 L 3.00 P .624 A2

LBBP (BLANK)

Catalog Number	Shank Diameter
	D
LBBP25	1/4
LBBP37	3/8
LBBP50	1/2
LBBP62	5/8
LBBP75	3/4
LBBP87	7/8
LBBP100	1

EXAMPLE: 10 LBBP50 L 2.00 M2



LBBK (EJECTOR BLANK)

Catalog Number	Shank Diameter	Ejector Group
	D	Cat. No.
LBBK25	1/4	KP2*, KP 23
LBBK37	3/8	KP4
LBBK50	1/2	KP6
LBBK62	5/8	KP6
LBBK75	3/4	KP9
LBBK87	7/8	KP9
LBBK100	1	KP9

EXAMPLE: 8 LBBK62 L 2.00 A2

Shank Diameter	Overall Lengths (Blanks) Nominal Lengths (Pilots)							
	D	2	2-1/4	2-1/2	2-3/4	3	3-1/2	4
1/4 (.250)		2.00	2.25	2.50	2.75	3.00	–	–
3/8 (.375)		2.00	2.25	2.50	2.75	3.00	3.50	–
1/2 (.500)		2.00	2.25	2.50	2.75	3.00	3.50	4.00
5/8 (.625)		2.00	2.25	2.50	2.75	3.00	3.50	4.00
3/4 (.750)		2.00	2.25	2.50	2.75	3.00	3.50	4.00
7/8 (.875)		2.00	2.25	2.50	2.75	3.00	3.50	4.00
1 (1.000)		2.00	2.25	2.50	2.75	3.00	3.50	4.00

* On LBBK 25, please specify ejector group: LBBK 252 (KP2) or LBBK 253 (KP23).
Ejector components and design data are shown in the Misc. Products Section.

Light Duty

Material: A2 – 5% Chrome; M2 – High Speed Steel

Hardness: Point and Shank Rc 60-63

Concentricity: Point to Shank (P:D): .0005 T.I.R. (Max.)

How to order:

Please specify: Quantity, catalog number, nominal length, point diameter and material.

See ordering examples.

NOTE: If material is not specified, M2 will be provided.

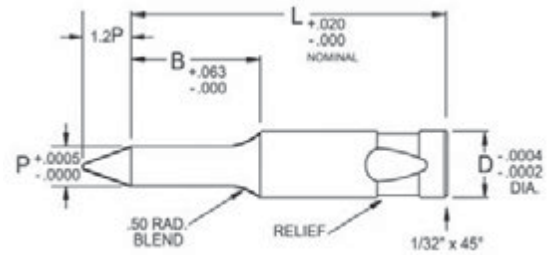

LBPA

Catalog Number	Shank Diameter	Range of Point Diameter		Point Length
		P Min.	P Max.	B
LBPA37	3/8	.186	.374	5/8
LBPA50	1/2	.249	.499	3/4
LBPA62	5/8	.311	.624	7/8
LBPA75	3/4	.436	.749	15/16
LBPA87	7/8	.624	.874	15/16
LBPA100	1	.749	.999	15/16

EXAMPLE: 6 LBPA37 L 2.75 P .249 A2

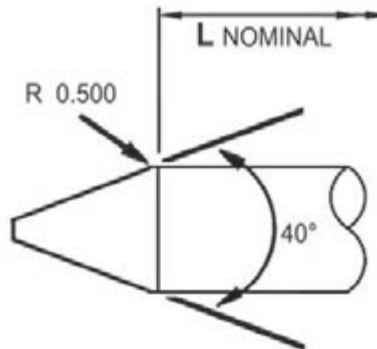

NOTE: Under .186 Point Diameter, Nose is 1.5P

Shank Diameter	Nominal Lengths L						
	D	2-1/2	2-3/4	3	3-1/4	3-1/2	3-3/4
3/8 (.375)	2.50	2.75	3.00	3.25	3.50	–	–
1/2 (.500)	2.50	2.75	3.00	3.25	3.50	3.75	4.00
5/8 (.625)	2.50	2.75	3.00	3.25	3.50	3.75	4.00
3/4 (.750)	2.50	2.75	3.00	3.25	3.50	3.75	4.00
7/8 (.875)	2.50	2.75	3.00	3.25	3.50	3.75	4.00
1 (1.000)	2.50	2.75	3.00	3.25	3.50	3.75	4.00

Die Buttons



Light Duty

Material: A2 – 5% Chrome; M2 – High Speed Steel

Hardness: Hole and Body Rc 60-63

Concentricity: Hole to Body (P:D)

ROUND: .0005 T.I.R. (Max.)

SHAPES: .0010 T.I.R. (Max.)

For rectangular die holes: The specified "P" and "W" dimensions must not result in a shape diagonal greater than the "G" maximum listed in the chart.

*** D Tolerances:**
 -.0007 to -.0002 for D, up to 1"
 -.0010 to -.0003 for D > 1"

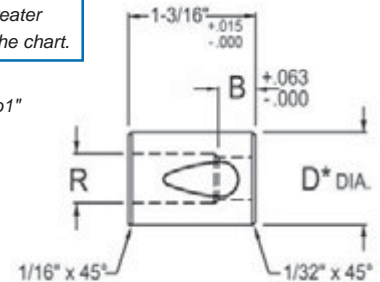

How to order:

Please specify: Quantity, catalog number, hole dimensions and material.

See ordering examples.

NOTE: A2 or M2 material will be selected at our discretion, unless specified.

LBCD (ROUND)

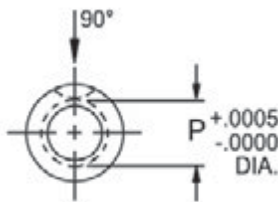

Standard ball seat location shown (↓).
 Ball seat location other than standard must be specified.

Body Diameter	Catalog Number	Die Hole Range		Relief Hole R	Min. Wear Land B
		P Min.	P Max.		
1/2 (.500)	LBCD50	.064	.195	.228	.156
5/8 (.625)	LBCD62	.126	.285	.312	.187
3/4 (.750)	LBCD75	.196	.345	.375	.187
7/8 (.875)	LBCD87	.286	.435	.468	.187
1 (1.000)	LBCD100	.346	.545	.578	.250
1-1/4 (1.250)	LBCD125	.436	.655	.687	.250
1-1/2 (1.500)	LBCD150	.546	.780	.812	.250
1-3/4 (1.750)	LBCD175	.656	1.035	1.062	.312

EXAMPLE: 5 LBCD50 P .125 A2

LBOD (OBLONG)

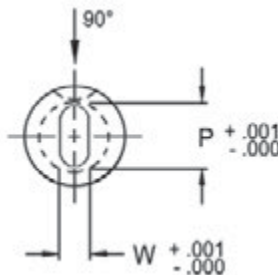

LBRD (RECTANGLE, INCLUDES SQUARE)

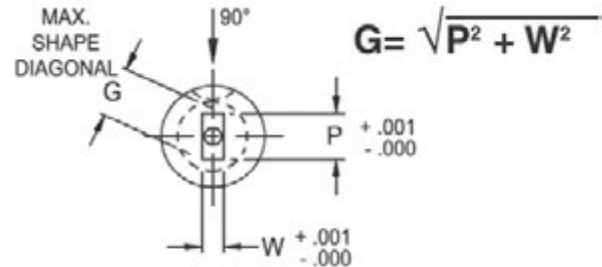

Body Diameter	Catalog Number	Die Hole Range		Relief Hole R	Min. Wear Land B
		P Max.	W Min.		
1/2 (.500)	LBOD50	.195	.048	.228	.156
5/8 (.625)	LBOD62	.285	.064	.312	.187
3/4 (.750)	LBOD75	.345	.095	.375	.187
7/8 (.875)	LBOD87	.435	.127	.468	.187
1 (1.000)	LBOD100	.545	.158	.578	.250
1-1/4 (1.250)	LBOD125	.655	.189	.687	.250
1-1/2 (1.500)	LBOD150	.780	.220	.812	.250
1-3/4 (1.750)	LBOD175	1.035	.252	1.062	.312

EXAMPLE: 2 LBOD62 P .284 M2

Body Diameter	Catalog Number	Die Hole Range		Relief Hole R	Min. Wear Land B
		G Max.	W Min.		
1/2 (.500)	LBRD50	.195	.048	.228	.156
5/8 (.625)	LBRD62	.285	.064	.312	.187
3/4 (.750)	LBRD75	.345	.095	.375	.187
7/8 (.875)	LBRD87	.435	.127	.468	.187
1 (1.000)	LBRD100	.545	.158	.578	.250
1-1/4 (1.250)	LBRD125	.655	.189	.687	.250
1-1/2 (1.500)	LBRD150	.780	.220	.812	.250
1-3/4 (1.750)	LBRD175	1.035	.252	1.062	.312

EXAMPLE: 4 LBRD75 P .252 M2

Heavy Duty

Material: A2 – 5% Chrome; M2 – High Speed Steel

Hardness: Point and Shank Rc 60-63

Concentricity: Point to Shank (P:D)

ROUND: .0005 T.I.R. (Max.)

SHAPES: .0010 T.I.R. (Max.)

How to order:

Please specify: Quantity, catalog number, overall length, point dimensions and material.

See ordering examples.

NOTE: If material is not specified, M2 will be provided.

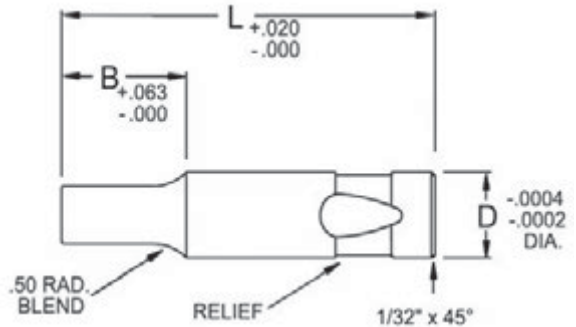

HBCP (ROUND)

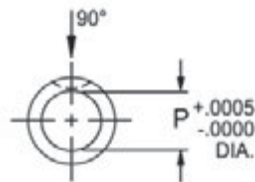

Catalog Number	Shank Diameter	Range of Point Diameter	
		P Min.	P Max.
HBCP37	3/8	.125	.374
HBCP50	1/2	.187	.499
HBCP62	5/8	.375	.624
HBCP75	3/4	.500	.749
HBCP87	7/8	.625	.874
HBCP100	1	.750	.999
HBCP125	1-1/4	1.000	1.249

EXAMPLE: 6 HBCP62 L 3.50 P .500 M2

The specified P & W dimensions must not result in a shape diagonal greater than G Max. listed in the chart.

Standard ball seat location shown (↓). Ball seat location other than standard must be specified.

HBOP (OBLONG)

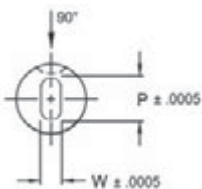

Catalog Number	Shank Diameter	Range of Point Dimensions	
		P Max.	W Min.
HBOP37	3/8	.374	.125
HBOP50	1/2	.499	.187
HBOP62	5/8	.624	.250
HBOP75	3/4	.749	.312
HBOP87	7/8	.874	.375
HBOP100	1	.999	.437
HBOP125	1-1/4	1.249	.500

EXAMPLE: 6 HBOP62 L 2.50 P .500 W .375 M2

HBRP (RECTANGLE, INCLUDES SQUARE)

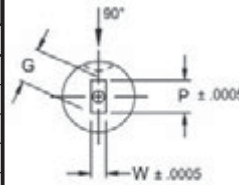

$$G = \sqrt{P^2 + W^2}$$

Catalog Number	Shank Diameter	Range of Point Dimensions	
		G Max.	W Min.
HBRP37	3/8	.374	.125
HBRP50	1/2	.499	.187
HBRP62	5/8	.624	.250
HBRP75	3/4	.749	.312
HBRP87	7/8	.874	.375
HBRP100	1	.999	.437
HBRP125	1-1/4	1.249	.500

EXAMPLE: 6 HBRP50 L 3.50 P .313 W .187 M2

Shank Diameter	Overall Lengths L	Point Length						
			D	2-1/2	2-3/4	3	3-1/4	3-1/2
3/8 (.375)	2.50 2.75 3.00 3.25 3.50 4.00	5/8						
1/2 (.500)	2.50 2.75 3.00 3.25 3.50 4.00 5.00	13/16						
5/8 (.625)	2.50 2.75 3.00 3.25 3.50 4.00 5.00	15/16						
3/4 (.750)	2.50 2.75 3.00 3.25 3.50 4.00 5.00	1-1/16						
7/8 (.875)	– 2.75 3.00 3.25 3.50 4.00 5.00	1-3/16						
1 (1.000)	– – 3.00 3.25 3.50 4.00 5.00	1-1/4						
1-1/4 (1.250)	– – 3.00 3.25 3.50 4.00 5.00	1-7/16						

Ejector Perforating Punches



Heavy Duty

Material: A2 – 5% Chrome; M2 – High Speed Steel

Hardness: Point and Shank Rc 60-63

Concentricity: Point to Shank (P:D)

ROUND: .0005 T.I.R. (Max.)

SHAPES: .0010 T.I.R. (Max.)

How to order:

Please specify: Quantity, catalog number, overall length, point dimensions and material.

See ordering examples.

NOTE: If material is not specified, M2 will be provided.

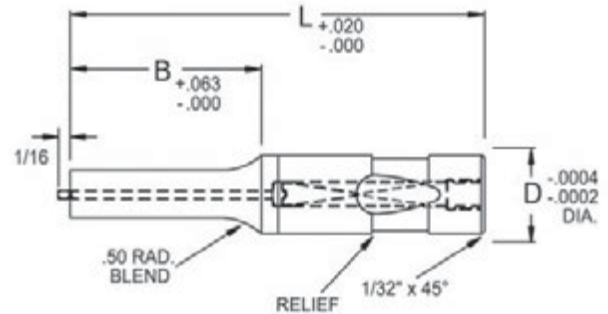

HBCK (ROUND)

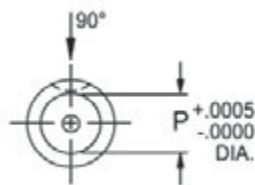

Standard ball seat location shown (▼).
Ball seat location other than standard must be specified.

Catalog Number	Shank Diameter	Range of Point Diameter	
		P Min.	P Max.
HBCK37	3/8	.125	.374
HBCK50	1/2	.250	.499
HBCK62	5/8	.375	.624
HBCK75	3/4	.500	.749
HBCK87	7/8	.625	.874
HBCK100	1	.750	.999
HBCK125	1-1/4	1.000	1.249

EXAMPLE: 8 HBCK50 L 2.50 P .350 M2

The specified P & W dimensions must not result in a shape diagonal greater than G Max. listed in the chart.

HBOK (OBLONG)

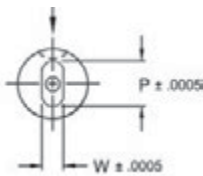

Catalog Number	Shank Diameter	Range of Point Dimensions	
		P Max.	W Min.
HBOK37	3/8	.374	.125
HBOK50	1/2	.499	.187
HBOK62	5/8	.624	.250
HBOK75	3/4	.749	.312
HBOK87	7/8	.874	.375
HBOK100	1	.999	.437
HBOK125	1-1/4	1.249	.500

EXAMPLE: 6 HBOK62 L 2.50 P .500 W .375 M2

HBRK (RECTANGLE, INCLUDES SQUARE)

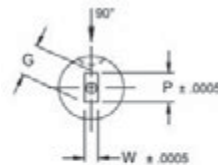

$$G = \sqrt{P^2 + W^2}$$

Catalog Number	Shank Diameter	Range of Point Dimensions	
		G Max.	W Min.
HBRK37	3/8	.374	.125
HBRK50	1/2	.499	.187
HBRK62	5/8	.624	.250
HBRK75	3/4	.749	.312
HBRK87	7/8	.874	.375
HBRK100	1	.999	.437
HBRK125	1-1/4	1.249	.500

EXAMPLE: 7 HBRK75 L 4.00 P .475 W .350 M2

Shank Diameter	D	Overall Lengths L							Pt. Length	Ejector Grp.
		2-1/2	2-3/4	3	3-1/4	3-1/2	4	5		
3/8	(.375)	2.50	2.75	3.00	3.25	3.50	4.00	–	5/8	KP4
1/2	(.500)	2.50	2.75	3.00	3.25	3.50	4.00	5.00	13/16	KP6
5/8	(.625)	2.50	2.75	3.00	3.25	3.50	4.00	5.00	15/16	KP6
3/4	(.750)	2.50	2.75	3.00	3.25	3.50	4.00	5.00	1-1/16	KP9
7/8	(.875)	–	2.75	3.00	3.25	3.50	4.00	5.00	1-3/16	KP9
1	(1.000)	–	–	3.00	3.25	3.50	4.00	5.00	1-1/4	KP9
1-1/4	(1.250)	–	–	3.00	3.25	3.50	4.00	5.00	1-7/16	KP9

Ejector components and design data are shown in the Misc. Products Section.

Heavy Duty

Material: A2 – 5% Chrome; M2 – High Speed Steel

Hardness: Rc 60-63

Concentricity: Point to Shank (P:D) .0005 T.I.R. (Max.)

How to order:

Please specify: Quantity, catalog number, overall length, (point diameter and nominal lengths for Pilots) and material.

See ordering examples.

NOTE: If material is not specified, M2 will be provided.

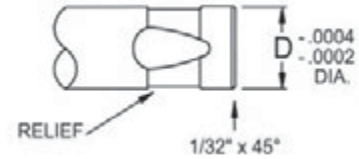

HBPP (PILOT)

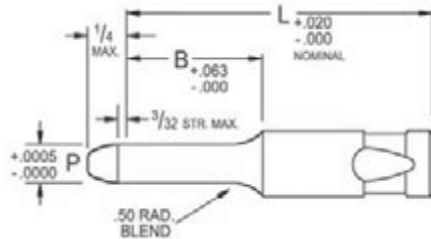

Catalog Number	Shank Diameter	Range of Point Diameter		Point Length
		P Min.	P Max.	
HBPP37	3/8	.124	.374	5/8
HBPP50	1/2	.186	.499	13/16
HBPP62	5/8	.374	.624	15/16
HBPP75	3/4	.499	.749	1-1/16
HBPP87	7/8	.624	.874	1-3/16
HBPP100	1	.749	.999	1-1/4
HBPP125	1-1/4	.999	1.249	1-7/16

EXAMPLE: 4 HBPP62 L 3.00 P .499 M2

HBBP (BLANK)

Catalog Number	Shank Diameter
	D
HBBP37	3/8
HBBP50	1/2
HBBP62	5/8
HBBP75	3/4
HBBP87	7/8
HBBP100	1
HBBP125	1-1/4

EXAMPLE: 7 HBBP50 L 2.50 M2

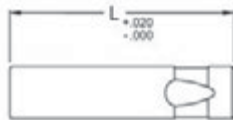

HBBK (EJECTOR BLANK)



Catalog Number	Shank Diameter	Ejector Group
	D	Cat. No.
HBBK37	3/8	KP4
HBBK50	1/2	KP6
HBBK62	5/8	KP6
HBBK75	3/4	KP9
HBBK87	7/8	KP9
HBBK100	1	KP9
HBBK125	1-1/4	KP9

EXAMPLE: 3 HBBK75 L 3.50 M2

Shank Diameter	Overall Lengths (Blanks)							
	Nominal Lengths (Pilots)							
D	2-1/2	2-3/4	3	3-1/4	3-1/2	4	5	
3/8 (.375)	2.50	2.75	3.00	3.25	3.50	4.00	–	
1/2 (.500)	2.50	2.75	3.00	3.25	3.50	4.00	5.00	
5/8 (.625)	2.50	2.75	3.00	3.25	3.50	4.00	5.00	
3/4 (.750)	2.50	2.75	3.00	3.25	3.50	4.00	5.00	
7/8 (.875)	–	2.75	3.00	3.25	3.50	4.00	5.00	
1 (1.000)	–	–	3.00	3.25	3.50	4.00	5.00	
1-1/4 (1.250)	–	–	3.00	3.25	3.50	4.00	5.00	

Ejector components and design data are shown in the Misc. Products Section.

“A” Type Pilot Punches



Heavy Duty

Material: A2 – 5% Chrome; M2 – High Speed Steel

Hardness: Point and Shank Rc 60-63

Concentricity: Point to Shank (P:D) .0005 T.I.R. (Max.)

How to order:

Please specify: Quantity, catalog number, nominal length, point diameter and material.

See ordering examples.

NOTE: If material is not specified, M2 will be provided.

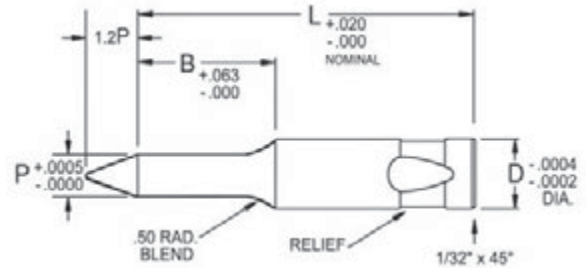

HBPA

Catalog Number	Shank Diameter	Range of Point Diameter		Point Length
		P Min.	P Max.	B
HBPA37	3/8	.186	.374	5/8
HBPA50	1/2	.249	.499	13/16
HBPA62	5/8	.311	.624	15/16
HBPA75	3/4	.436	.749	1-1/16
HBPA87	7/8	.624	.874	1-3/16
HBPA100	1	.749	.999	1-1/4
HBPA125	1-1/4	.999	1.249	1-7/16

EXAMPLE: 6 HBPA50 L 2.75 P .249 A2

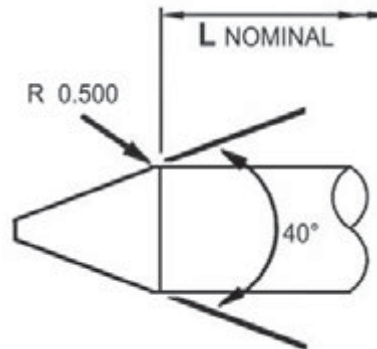

NOTE: Under .186 Point Diameter, Nose is 1.5P

Shank Diameter	Nominal Lengths L										
	D	2-1/2	2-3/4	3	3-1/4	3-1/2	3-3/4	4	4-1/4	4-1/2	4-3/4
3/8 (.375)		2.50	2.75	3.00	3.25	3.50	3.75	4.00	–	–	–
1/2 (.500)		2.50	2.75	3.00	3.25	3.50	3.75	4.00	4.25	4.50	4.75
5/8 (.625)		2.50	2.75	3.00	3.25	3.50	3.75	4.00	4.25	4.50	4.75
3/4 (.750)		2.50	2.75	3.00	3.25	3.50	3.75	4.00	4.25	4.50	4.75
7/8 (.875)		–	2.75	3.00	3.25	3.50	3.75	4.00	4.25	4.50	4.75
1 (1.000)		–	–	3.00	3.25	3.50	3.75	4.00	4.25	4.50	4.75
1-1/4 (1.250)		–	–	3.00	3.25	3.50	3.75	4.00	4.25	4.50	4.75

Light Duty

Material: A2 – 5% Chrome; M2 – High Speed Steel

Hardness: Point and Shank Rc 60-63

Concentricity: Point to Shank (P:D)

ROUND: .0005 T.I.R. (Max.)

SHAPES: .0010 T.I.R. (Max.)

The specified P & W dimensions must not result in a shape diagonal greater than G Max. listed in the chart.

How to order:

Please specify: Quantity, catalog number, overall length, point dimensions and material.

See ordering examples.

NOTE: If material is not specified, M2 will be provided.

NOTE: Ball seat is standard as shown. Ball seat 90° from standard is available as a no cost option. Any other location will require a drawing.

LKCP (ROUND)

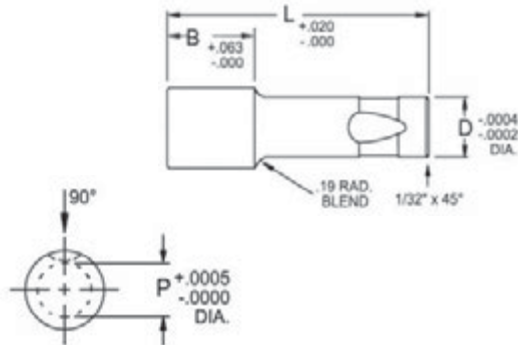

Catalog Number	Shank Diam.	Point Range		Overall Lengths L				B
		P Min.	P Max.	2-1/2	3	3-1/2	4	
	D							
LKCP50	1/2	.501	1.250	2.50	3.00	3.50	4.00	3/4
LKCP62	5/8	.626	1.500	2.50	3.00	3.50	4.00	7/8
LKCP75	3/4	.751	1.500	2.50	3.00	3.50	4.00	15/16
LKCP87	7/8	.876	1.750	2.50	3.00	3.50	4.00	15/16
LKCP100	1	1.001	1.750	2.50	3.00	3.50	4.00	15/16

EXAMPLE: 6 LKCP62 L 4.00 P 1.250 M2

LKOP (OBLONG)

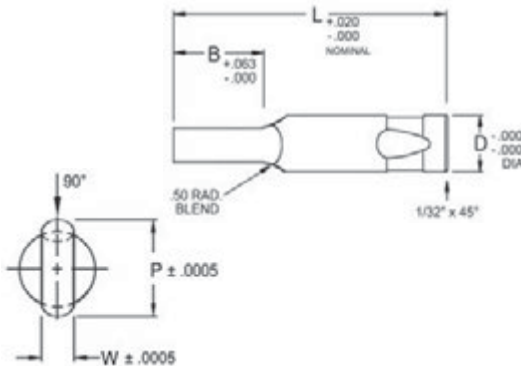

Catalog Number	Shank Diam.	Point Range		Overall Lengths L				B
		P Max.	W Min.	2-1/2	3	3-1/2	4	
	D							
LKOP50	1/2	1.250	.188	2.50	3.00	3.50	4.00	3/4
LKOP62	5/8	1.500	.250	2.50	3.00	3.50	4.00	7/8
LKOP75	3/4	1.500	.312	2.50	3.00	3.50	4.00	15/16
LKOP87	7/8	1.750	.375	2.50	3.00	3.50	4.00	15/16
LKOP100	1	1.750	.437	2.50	3.00	3.50	4.00	15/16

EXAMPLE: 6 LKOP62 L 4.00 P 1.250 W .300 M2

LKRP (RECTANGLE, INCLUDES SQUARE)

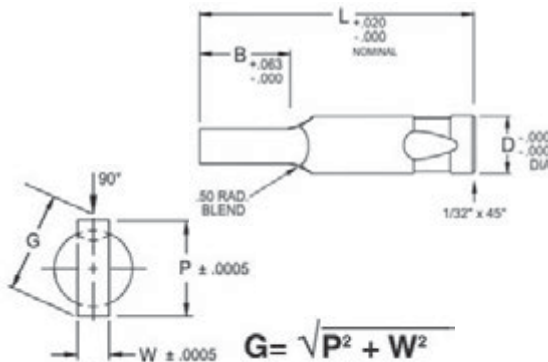

Catalog Number	Shank Diam.	Point Range		Overall Lengths L				B
		G Max.	W Min.	2-1/2	3	3-1/2	4	
	D							
LKRP50	1/2	1.250	.188	2.50	3.00	3.50	4.00	3/4
LKRP62	5/8	1.500	.250	2.50	3.00	3.50	4.00	7/8
LKRP75	3/4	1.500	.312	2.50	3.00	3.50	4.00	15/16
LKRP87	7/8	1.750	.375	2.50	3.00	3.50	4.00	15/16
LKRP100	1	1.750	.437	2.50	3.00	3.50	4.00	15/16

EXAMPLE: 6 LKRP62 L 4.00 P 1.250 W .300 M2

Ejector Knob Punches



Light Duty

Material: A2 – 5% Chrome; M2 – High Speed Steel

Hardness: Point and Shank Rc 60-63

Concentricity: Point to Shank (P:D)

ROUND: .0005 T.I.R. (Max.)

SHAPES: .0010 T.I.R. (Max.)

The specified P & W dimensions must not result in a shape diagonal greater than G Max. listed in the chart.

How to order:

Please specify: Quantity, catalog number, overall length, point dimensions and material.

See ordering examples.

NOTE: If material is not specified, M2 will be provided.

NOTE: Ball seat is standard as shown. Ball seat 90° from standard is available as a no cost option. Any other location will require a drawing.

LKCK (ROUND)

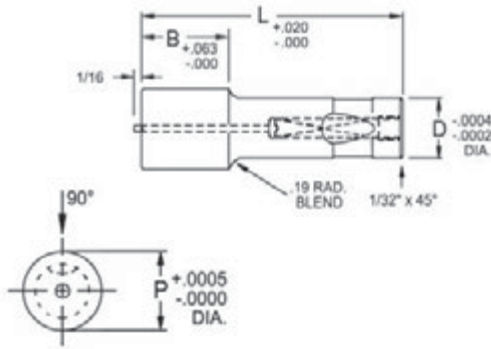

Catalog Number	Shank Diam.	Point Range		Overall Lengths L				B	Ejector Group
		P Min.	P Max.	2-1/2	3	3-1/2	4		
LKCK50	1/2	.501	1.250	2.50	3.00	3.50	4.00	3/4	KP6
LKCK62	5/8	.626	1.500	2.50	3.00	3.50	4.00	7/8	KP6
LKCK75	3/4	.751	1.500	2.50	3.00	3.50	4.00	15/16	KP9
LKCK87	7/8	.876	1.750	2.50	3.00	3.50	4.00	15/16	KP9
LKCK100	1	1.001	1.750	2.50	3.00	3.50	4.00	15/16	KP9

EXAMPLE: 6 LKCK62 L 4.00 P 1.250 M2

LKOK (OBLONG)

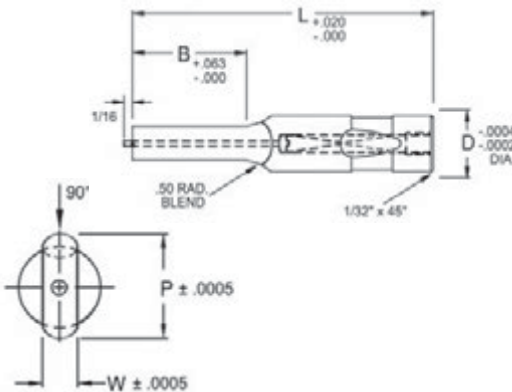

Catalog Number	Shank Diam.	Point Range		Overall Lengths L				B	Ejector Group
		P Max.	W Min.	2-1/2	3	3-1/2	4		
LKOK50	1/2	1.250	.188	2.50	3.00	3.50	4.00	3/4	KP6
LKOK62	5/8	1.500	.250	2.50	3.00	3.50	4.00	7/8	KP6
LKOK75	3/4	1.500	.312	2.50	3.00	3.50	4.00	15/16	KP9
LKOK87	7/8	1.750	.375	2.50	3.00	3.50	4.00	15/16	KP9
LKOK100	1	1.750	.437	2.50	3.00	3.50	4.00	15/16	KP9

EXAMPLE: 6 LKOK62 L 4.00 P 1.250 W .300 M2

LKRK (RECTANGLE, INCLUDES SQUARE)

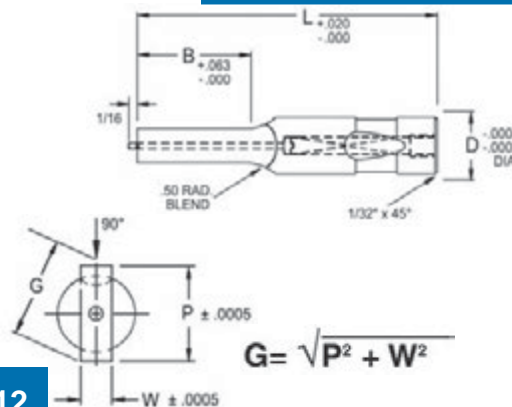

Catalog Number	Shank Diam.	Point Range		Overall Lengths L				B	Ejector Group
		G Max.	W Min.	2-1/2	3	3-1/2	4		
LKRK50	1/2	1.250	.188	2.50	3.00	3.50	4.00	3/4	KP6
LKRK62	5/8	1.500	.250	2.50	3.00	3.50	4.00	7/8	KP6
LKRK75	3/4	1.500	.312	2.50	3.00	3.50	4.00	15/16	KP9
LKRK87	7/8	1.750	.375	2.50	3.00	3.50	4.00	15/16	KP9
LKRK100	1	1.750	.437	2.50	3.00	3.50	4.00	15/16	KP9

EXAMPLE: 6 LKRK62 L 4.00 P 1.250 W .300 M2

Heavy Duty

Material: A2 – 5% Chrome; M2 – High Speed Steel

Hardness: Point and Shank Rc 60-63

Concentricity: Point to Shank (P:D)

ROUND: .0005 T.I.R. (Max.)

SHAPES: .0010 T.I.R. (Max.)

The specified P & W dimensions must not result in a shape diagonal greater than G Max. listed in the chart.

How to order:

Please specify: Quantity, catalog number, overall length, point dimensions and material.

See ordering examples.

NOTE: If material is not specified, M2 will be provided.

NOTE: Ball seat is standard as shown. Ball seat 90° from standard is available as a no cost option. Any other location will require a drawing.

HKCP (ROUND)

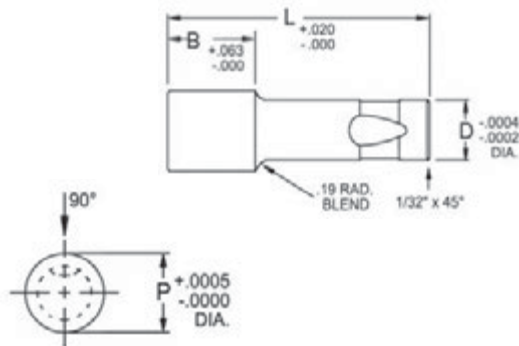

Catalog Number	Shank Diam. D	Point Range		Overall Lengths L				B
		P Min.	P Max.	2-1/2	3	3-1/2	4	
HKCP50	1/2	.501	1.250	2.50	3.00	3.50	4.00	3/4
HKCP62	5/8	.626	1.500	2.50	3.00	3.50	4.00	7/8
HKCP75	3/4	.751	1.500	2.50	3.00	3.50	4.00	15/16
HKCP87	7/8	.876	1.750	2.50	3.00	3.50	4.00	15/16
HKCP100	1	1.001	1.750	2.50	3.00	3.50	4.00	15/16
HKCP125	1-1/4	1.251	2.000	–	3.00	3.50	4.00	1-1/4

EXAMPLE: 6 HKCP62 L 4.00 P 1.250 M2

HKOP (OBLONG)

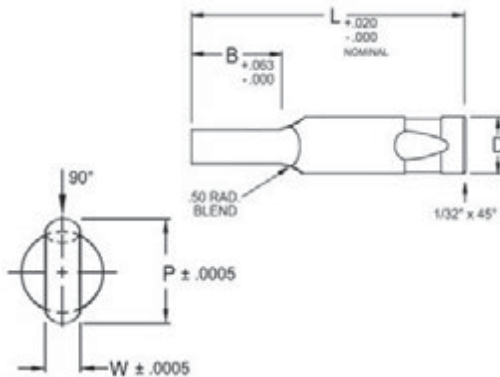

Catalog Number	Shank Diam. D	Point Range		Overall Lengths L				B
		P Max.	W Min.	2-1/2	3	3-1/2	4	
HKOP50	1/2	1.250	.188	2.50	3.00	3.50	4.00	3/4
HKOP62	5/8	1.500	.250	2.50	3.00	3.50	4.00	7/8
HKOP75	3/4	1.500	.312	2.50	3.00	3.50	4.00	15/16
HKOP87	7/8	1.750	.375	2.50	3.00	3.50	4.00	15/16
HKOP100	1	1.750	.437	2.50	3.00	3.50	4.00	15/16
HKOP125	1-1/4	2.000	.500	–	3.00	3.50	4.00	1-1/4

EXAMPLE: 6 HKOP62 L 4.00 P 1.250 W .300 M2

HKRP (RECTANGLE, INCLUDES SQUARE)

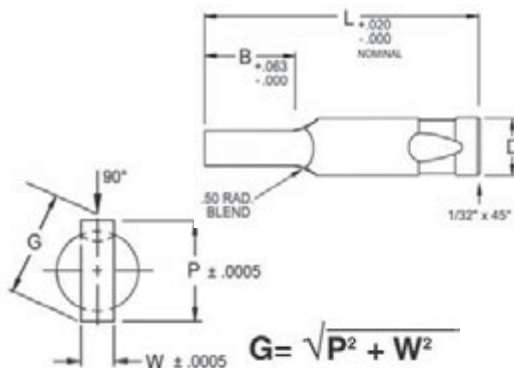

$$G = \sqrt{P^2 + W^2}$$

Catalog Number	Shank Diam. D	Point Range		Overall Lengths L				B
		G Max.	W Min.	2-1/2	3	3-1/2	4	
HKRP50	1/2	1.250	.188	2.50	3.00	3.50	4.00	3/4
HKRP62	5/8	1.500	.250	2.50	3.00	3.50	4.00	7/8
HKRP75	3/4	1.500	.312	2.50	3.00	3.50	4.00	15/16
HKRP87	7/8	1.750	.375	2.50	3.00	3.50	4.00	15/16
HKRP100	1	1.750	.437	2.50	3.00	3.50	4.00	15/16
HKRP125	1-1/4	2.000	.500	–	3.00	3.50	4.00	1-1/4

EXAMPLE: 6 HKRP62 L 4.00 P 1.250 W .300 M2

Ejector Knob Punches



Heavy Duty

Material: A2 – 5% Chrome; M2 – High Speed Steel

Hardness: Point and Shank Rc 60-63

Concentricity: Point to Shank (P:D)

ROUND: .0005 T.I.R. (Max.)

SHAPES: .0010 T.I.R. (Max.)

The specified P & W dimensions must not result in a shape diagonal greater than G Max. listed in the chart.

How to order:

Please specify: Quantity, catalog number, overall length, point dimensions and material.

See ordering examples.

NOTE: If material is not specified, M2 will be provided.

NOTE: Ball seat is standard as shown. Ball seat 90° from standard is available as a no cost option. Any other location will require a drawing.

HKCK (ROUND)

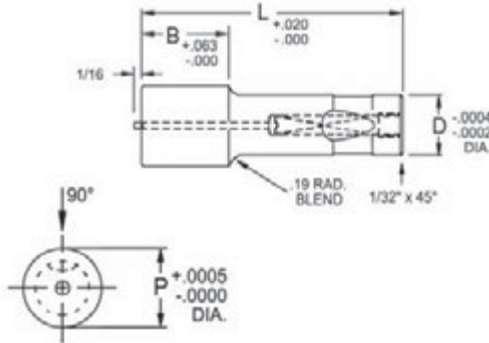

Catalog Number	Shank Diam.	Point Range		Overall Lengths L				B	Ejector Group
		P Min.	P Max.	2-1/2	3	3-1/2	4		
HKCK50	1/2	.501	1.250	2.50	3.00	3.50	4.00	3/4	KP6
HKCK62	5/8	.626	1.500	2.50	3.00	3.50	4.00	7/8	KP6
HKCK75	3/4	.751	1.500	2.50	3.00	3.50	4.00	15/16	KP9
HKCK87	7/8	.876	1.750	2.50	3.00	3.50	4.00	15/16	KP9
HKCK100	1	1.001	1.750	2.50	3.00	3.50	4.00	15/16	KP9
HKCK125	1-1/4	1.251	2.000	–	3.00	3.50	4.00	1-1/4	KP9

EXAMPLE: 6 HKCK62 L 4.00 P 1.250 M2

HKOK (OBLONG)

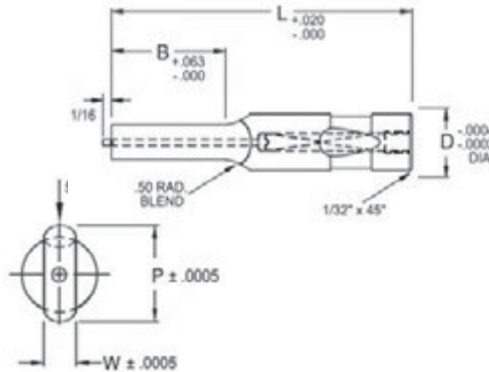

Catalog Number	Shank Diam.	Point Range		Overall Lengths L				B	Ejector Group
		P Max.	W Min.	2-1/2	3	3-1/2	4		
HKOK50	1/2	1.250	.188	2.50	3.00	3.50	4.00	3/4	KP6
HKOK62	5/8	1.500	.250	2.50	3.00	3.50	4.00	7/8	KP6
HKOK75	3/4	1.500	.312	2.50	3.00	3.50	4.00	15/16	KP9
HKOK87	7/8	1.750	.375	2.50	3.00	3.50	4.00	15/16	KP9
HKOK100	1	1.750	.437	2.50	3.00	3.50	4.00	15/16	KP9
HKOK125	1-1/4	2.000	.500	–	3.00	3.50	4.00	1-1/4	KP9

EXAMPLE: 6 HKOK62 L 4.00 P 1.250 W .300 M2

HKRK (RECTANGLE, INCLUDES SQUARE)

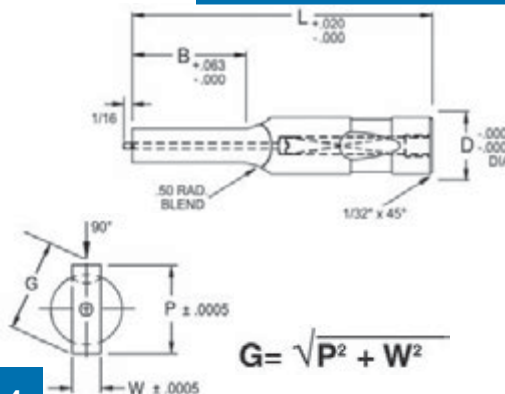

Catalog Number	Shank Diam.	Point Range		Overall Lengths L				B	Ejector Group
		G Max.	W Min.	2-1/2	3	3-1/2	4		
HKRK50	1/2	1.250	.188	2.50	3.00	3.50	4.00	3/4	KP6
HKRK62	5/8	1.500	.250	2.50	3.00	3.50	4.00	7/8	KP6
HKRK75	3/4	1.500	.312	2.50	3.00	3.50	4.00	15/16	KP9
HKRK87	7/8	1.750	.375	2.50	3.00	3.50	4.00	15/16	KP9
HKRK100	1	1.750	.437	2.50	3.00	3.50	4.00	15/16	KP9
HKRK125	1-1/4	2.000	.500	–	3.00	3.50	4.00	1-1/4	KP9

EXAMPLE: 6 HKRK62 L 4.00 P 1.250 W .300 M2

Light Duty

Material: Alloy Steel, carburized and hardened
Surface Hardness: Rc 54-60

How to order:
Please specify: Quantity and catalog number.

NOTES: 1. All fractional dimensions $\pm 1/64$ unless otherwise specified.
 2. Retainers must check to USA standard gages.

LBER (END TYPE RETAINERS)

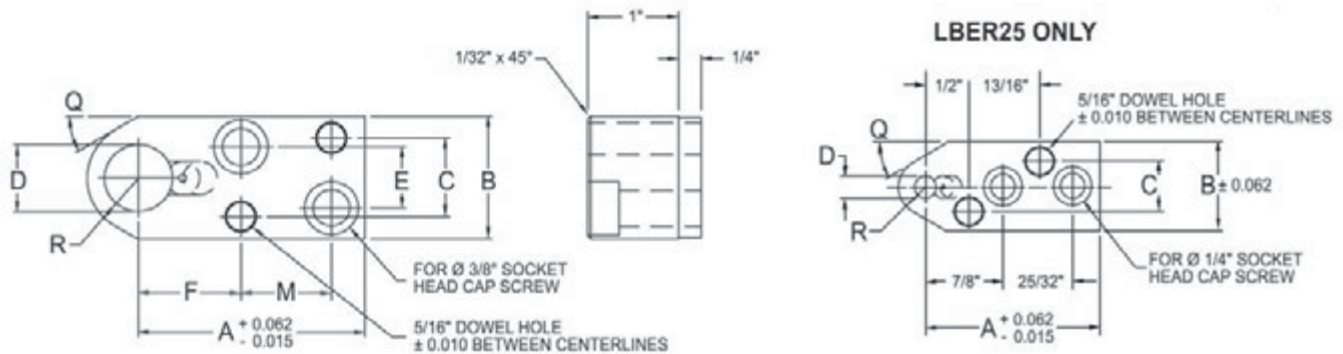

Catalog Number	Nominal D	C	E	F	M	A	Q	R	B
LBER25	1/4 (.250)	9/16	–	–	–	2	30°	5/16	1
LBER37	3/8 (.375)	3/4	9/16	29/32	31/32	2-1/4	30°	3/8	1-1/4
LBER50	1/2 (.500)	3/4	9/16	29/32	31/32	2-1/4	30°	9/16	1-1/4
LBER62	5/8 (.625)	3/4	9/16	29/32	31/32	2-1/4	30°	9/16	1-1/4
LBER75	3/4 (.750)	7/8	11/16	1-1/8	1	2-1/2	–	11/16	1-3/8
LBER87	7/8 (.875)	7/8	11/16	1-1/8	1	2-1/2	–	3/4	1-1/2
LBER100	1 (1.000)	7/8	11/16	1-1/8	1	2-1/2	–	13/16	1-5/8
LBER125	1-1/4 (1.250)	1-1/8	1-1/8	7/8	1-1/8	2-3/8	–	1	1-7/8

LBSR (SQUARE TYPE RETAINERS)

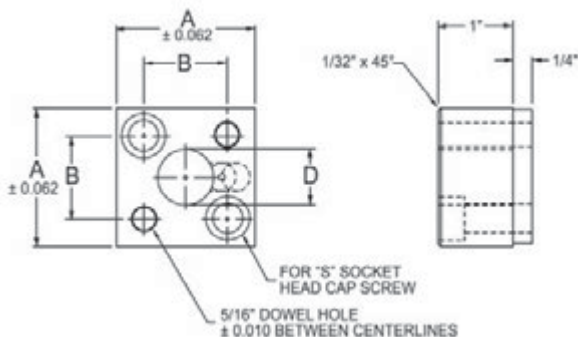

Catalog Number	Nominal D	A	B	S
LBSR25	1/4 (.250)	1-1/4	5/8	1/4
LBSR37	3/8 (.375)	1-3/8	3/4	5/16
LBSR50	1/2 (.500)	1-1/2	7/8	5/16
LBSR62	5/8 (.625)	1-5/8	1	5/16
LBSR75	3/4 (.750)	1-7/8	1-1/8	3/8
LBSR87	7/8 (.875)	2	1-1/4	3/8
LBSR100	1 (1.000)	2-1/4	1-1/2	3/8
LBSR125	1-1/4 (1.250)	2-1/4	1-1/2	3/8
LBSR150	1-1/2 (1.500)	2-3/4	2	3/8
LBSR175	1-3/4 (1.750)	2-3/4	2	3/8

Ball Lock Retainers



Heavy Duty

Material: Alloy Steel, carburized and hardened
Surface Hardness: Rc 54-60

How to order:
Please specify: Quantity and catalog number.

NOTES: 1. All fractional dimensions $\pm 1/64$ unless otherwise specified.
 2. Retainers must check to USA standard gages.

HBER (END TYPE RETAINERS)

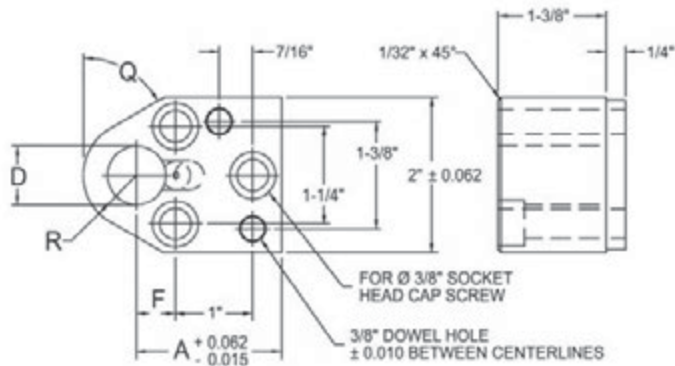

Catalog Number	Nominal D	A	F	Q	R
HBER50	1/2 (.500)	1-3/4	3/8	40°	1/2
HBER62	5/8 (.625)	1-13/16	7/16	45°	9/16
HBER75	3/4 (.750)	1-7/8	1/2	60°	11/16
HBER87	7/8 (.875)	1-15/16	9/16	60°	3/4
HBER100	1 (1.000)	2	5/8	60°	13/16
HBER125	1-1/4 (1.250)	2-1/8	3/4	—	1

HBSR (SQUARE TYPE RETAINERS)

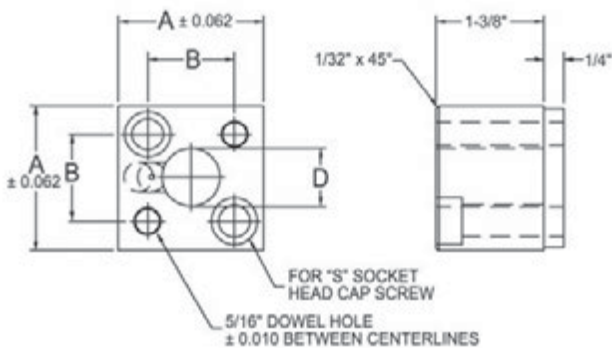

Catalog Number	Nominal D	A	B	S
HBSR50	1/2 (.500)	1-7/8	1-1/8	3/8
HBSR62	5/8 (.625)	2	1-1/4	3/8
HBSR75	3/4 (.750)	2-1/8	1-3/8	3/8
HBSR87	7/8 (.875)	2-3/8	1-1/2	1/2
HBSR100	1 (1.000)	2-3/8	1-1/2	1/2
HBSR125	1-1/4 (1.250)	2-5/8	1-5/8	1/2

Punchrite®

Quality you can rely on



Anchor Danly

CALL: 800-232-6592

FAX: 800-432-6594

www.anchorandaly.com
punchproducts@anchorandaly.com