

READY

THE INNOVATOR OF OUR INDUSTRY<sup>®</sup>

# SuperSprings<sup>®</sup>

*... They Simply Are the World's Finest Die Springs*



*We take die springs very seriously ... that's why we recently built the most sophisticated die spring manufacturing plant in the world. You won't find a better die spring at any price.*

*Not all die springs are the same. Compare SuperSprings® to the competition. You'll find ...*

- Longer Life (see next page) - less downtime means greater productivity.
- Consistent Dimensional Accuracy - tighter tolerances on free lengths and perpendicularity.
- Because our die springs are more dimensionally accurate, our spring rates are more accurate.
- Better Value - With SuperSprings®, you'll buy fewer die springs and lower your operating costs.
- We offer applications expertise, both technical support from our lab and sales support in the field.

*We are the die spring experts in our industry. Try our SuperSprings®, and you'll see the difference for yourself!*

## **SuperSprings®**

- **Four Load Classes, Guaranteed Fit, Fully Interchangeable**

More than 400 SuperSprings® are available in four color-coded load classifications. Uniform lengths and diameters provide full interchangeability between load ratings. Spring diameters are guaranteed to fit in the hole and over the rod diameters listed in the dimensional data. Lengths, diameters, rates, and colors are in accordance with ISO 10243.

- **Engineered for High Performance and Long Service Life**

Each SuperSpring® has the optimum design, pitch, and metallurgical content for efficient performance. Rectangular wire springs are made from a trapezoidal cross section wire, which changes to a "D" cross section during coiling. This shape results in a lower maximum stress level, substantially contributing to longer spring life.

READY® applies several advanced manufacturing processes to enhance the life of SuperSprings®. These include precision heat treating, shot peening to reduce mechanical stresses, and presetting by compressing to solid for increased set resistance and greatest resistance to fatigue.

- **Dependable Performance Is Quality-Assured**

SuperSprings® are manufactured exclusively from vacuum degassed, valve spring quality alloy steel. State-of-the-art equipment, including CNC coiling and grinding, is employed to achieve consistent dimensional accuracy within narrowest tolerances. Each production run is thoroughly inspected and documented to maintain strict quality. The result is a die spring of unsurpassed quality which many of the world's most demanding users specify for long, dependable performance.

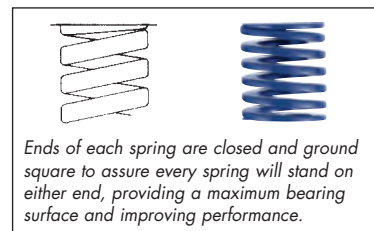
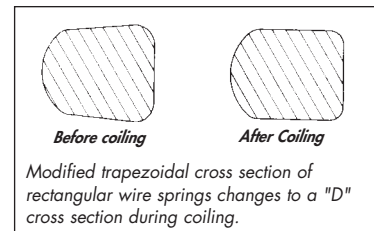

# SuperSprings® Selection and Use

Take A Closer Look ...

As the ratio of preload to total deflection increases, spring life increases. We recommend that you use a generous preload in your tool design whenever possible.

As the ratio of total deflection to free length decreases, spring life increases. Spring life can often be

improved by drilling the spring pockets deeper and selecting the next longer spring.

The chart below and the spring tables presented on the following pages are designed to help you quickly select the die spring best suited to your needs.

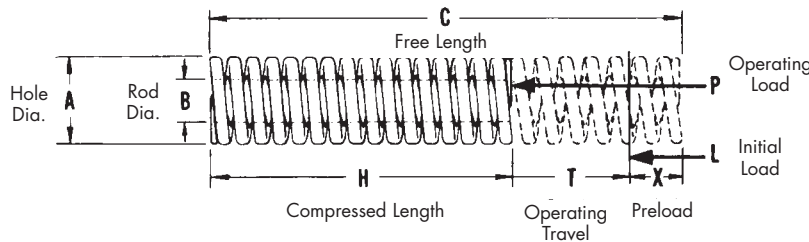

## Converting Compressed Lengths to Free Lengths

Light Load				Medium Load				Heavy Load				Extra Heavy Load			
H-Compressed Length Compression			C	H-Compressed Length Compression			C	H-Compressed Length Compression			C	H-Compressed Length Compression			C
Long Life 25%	Average Life 30%	Maximum Deflection 40%	Free Length	Long Life 25%	Average Life 30%	Maximum Deflection 37.5%	Free Length	Long Life 20%	Average Life 25%	Maximum Deflection 30%	Free Length	Long Life 17%	Average Life 20%	Maximum Deflection 25%	Free Length
<b>Inch Conversion</b>															
0.75	0.69	0.58	1	0.75	0.69	0.61	1	0.79	0.75	0.69	1	0.82	0.79	0.75	1
0.94	0.89	0.77	1 1/4	0.94	0.89	0.79	1 1/4	1.02	0.94	0.89	1 1/4	1.04	1.02	0.94	1 1/4
1.02	1.06	0.91	1 1/2	1.12	1.06	0.94	1 1/2	1.20	1.12	1.06	1 1/2	1.24	1.20	1.12	1 1/2
1.30	1.22	1.02	1 3/4	1.30	1.22	1.06	1 3/4	1.38	1.30	1.22	1 3/4	1.44	1.38	1.30	1 3/4
1.50	1.42	1.22	2	1.50	1.42	1.26	2	1.61	1.50	1.42	2	1.67	1.61	1.50	2
1.89	1.77	1.54	2 1/2	1.89	1.77	1.57	2 1/2	2.01	1.89	1.77	2 1/2	2.09	2.01	1.89	2 1/2
2.24	2.09	1.81	3	2.24	2.09	1.85	3	2.40	2.24	2.09	3	2.48	2.40	2.24	3
2.64	2.44	2.13	3 1/2	2.64	2.44	2.20	3 1/2	2.80	2.64	2.44	3 1/2	2.91	2.80	2.64	3 1/2
3.03	2.80	2.40	4	3.03	2.80	2.52	4	3.23	3.03	2.80	4	3.35	3.23	3.03	4
3.39	3.19	2.72	4 1/2	3.39	3.19	2.83	4 1/2	3.62	3.39	3.19	4 1/2	3.74	3.62	3.39	4 1/2
3.74	3.50	2.99	5	3.74	3.50	3.11	5	4.02	3.74	3.50	5	4.13	4.02	3.74	5
4.13	3.86	3.31	5 1/2	4.13	3.86	3.46	5 1/2	4.41	4.13	3.86	5 1/2	4.57	4.41	4.13	5 1/2
4.49	4.17	3.58	6	4.49	4.17	3.74	6	4.80	4.49	4.17	6	4.96	4.80	4.49	6
5.24	4.92	4.21	7	5.24	4.92	4.37	7	5.63	5.24	4.92	7	5.83	5.63	5.24	7
5.98	5.59	4.80	8	5.98	5.59	5.00	8	6.38	5.98	5.59	8	6.61	6.38	5.98	8
0.00	0.00	0.00	9	6.77	6.30	5.63	9	0.00	0.00	0.00	9	0.00	0.00	0.00	9
7.52	7.01	10.00	10	7.52	7.01	6.26	10	7.99	7.52	7.01	10	8.31	7.99	7.52	10
9.02	8.39	12.01	12	9.02	8.39	7.52	12	9.61	9.02	8.39	12	9.96	9.61	9.02	12
<b>Metric Conversion</b>															
19	17.5	14.8	25	19	17.5	15.5	25	20	19	17.5	25	20.8	20	19	25
24	22.5	19.5	32	24	22.5	20	32	26	24	22.5	32	26.5	26	24	32
25.8	27	23	38	28.5	27	24	38	30.5	28.5	27	38	31.5	30.5	28.5	38
33	31	26	44	33	31	27	44	35	33	31	44	36.5	35	33	44
38	36	31	51	38	36	32	51	41	38	36	51	42.5	41	38	51
48	45	39	64	48	45	40	64	51	48	45	64	53	51	48	64
57	53	46	76	57	53	47	76	61	57	53	76	63	61	57	76
67	62	54	89	67	62	56	89	71	67	62	89	74	71	67	89
77	71	61	102	77	71	64	102	82	77	71	102	85	82	77	102
86	81	69	115	86	81	72	115	92	86	81	115	95	92	86	115
95	89	76	127	95	89	79	127	102	95	89	127	105	102	95	127
105	98	84	140	105	98	88	140	112	105	98	140	116	112	105	140
114	106	91	152	114	106	95	152	122	114	106	152	126	122	114	152
133	125	107	178	133	125	111	178	143	133	125	178	148	143	133	178
152	142	122	203	152	142	127	203	162	152	142	203	168	162	152	203
----	----	----	----	172	160	143	229	----	----	----	----	----	----	----	----
191	178	254	254	191	178	159	254	203	191	178	254	211	203	191	254
229	213	305	305	229	213	191	305	244	229	213	305	253	244	229	305

Most die spring manufacturers will claim that based upon in-house testing, their spring outperforms the competition.

To eliminate all bias, we went outside and asked the prestigious Spring Research and Manufacturer's Association to life test our SuperSpring® against the competition. The results of this independent test, certified under Test Certificate No. 002860, prove\* the long-life performance of our SuperSpring®:

The springs were cycled between lengths corresponding to the 'catalog' maximum deflection conditions of 23.97mm and 18.80mm at a test speed of 3000 cycles/minute.

The results have also been analyzed by means of the 'weibull' technique, and a value of 'B10' (the life in cycles which 90% of springs would be expected to survive without failure) determined for each batch.

The B10 values are:		
READY SuperSprings®		333,139
RAYMOND springs		152,159
DANLY DIE SET springs		117,706

Ready SuperSprings®  
(color code yellow)

Spring No.	Cycles	Broken	Unbroken
1	466,450	X	
2	10,000,000		X
3	3,043,070	X	
4	1,995,730	X	
5	10,000,000		X
6	10,000,000		X
7	10,000,000		X
8	314,670	X	
9	10,000,000		X
10	10,000,000		X

Danly Die Set Springs  
(color code yellow/green)

Spring No.	Cycles	Broken	Unbroken
1	238,290	X	
2	286,540	X	
3	178,390	X	
4	138,640	X	
5	231,390	X	
6	199,170	X	
7	114,490	X	
8	144,870	X	
9	136,010	X	
10	211,740	X	

Raymond Springs  
(color code green)

Spring No.	Cycles	Broken	Unbroken
1	185,000	X	
2	156,760	X	
3	166,160	X	
4	164,410	X	
5	154,530	X	
6	9,000,860	X	
7	157,470	X	
8	198,250	X	
9	152,030	X	
10	167,680	X	

\*1. Every effort was made to test representative samples. SuperSprings were randomly selected from stock, and competitors' springs were supplied against a purchase order. The possibility remains, however, that these samples may somehow not be representative.

2. This is a test on only one spring size and one specific set of operating conditions, performed in a laboratory environment; it may not be typical of the way you use springs. We urge you to run a comparison life test in your own plant and compare the fatigue life of our SuperSpring to those of our competitors under actual manufacturing conditions.

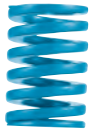

**LIGHT LOAD**

Vacuum degassed,  
valve spring quality alloy steel

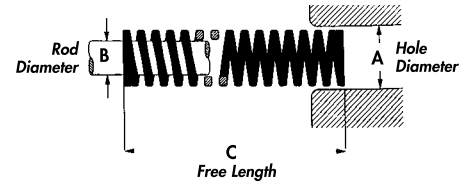

Sizes: 3/8" to 1", Rectangular Wire Construction

Color: Green

Hole Dia. in.	Rod Dia. in.	Free Length in.	CATALOG NUMBER	RATE Pounds Required to Deflect 1/10 in.	LOAD - DEFLECTION TABLE							
					Total Deflection Recommended for Long Life (25% of C)		Total Deflection Recommended for Average Life (30% of C)		Maximum Operating Deflection (40% of C)		Total Travel to Solid	
					Load lbs.	Deflection Inches	Load lbs.	Deflection Inches	Load lbs.	Deflection Inches	Load lbs.	Deflection Inches
<b>Rectangular Wire Construction</b>												
3/8	3/16	1	9 - 0604 - LE	5.7	14	0.25	17	0.30	23	0.40	34	0.59
		1.25	9 - 0605 - LE	4.9	15	0.31	18	0.38	24	0.50	36	0.75
		1.5	9 - 0606 - LE	3.9	15	0.38	17	0.45	23	0.60	35	0.91
		1.75	9 - 0607 - LE	3.4	15	0.44	18	0.53	24	0.70	36	1.06
		2	9 - 0608 - LE	2.9	14	0.50	17	0.60	23	0.80	35	1.22
		2.5	9 - 0610 - LE	2.5	15	0.63	18	0.75	25	1.00	40	1.61
		3	9 - 0612 - LE	1.8	14	0.75	16	0.90	22	1.20	35	1.89
		12	9 - 0648 - LE	0.6	19	3.00	23	3.60	30	4.80	46	7.36
1/2	9/32	1	9 - 0804 - LE	10.2	26	0.25	31	0.30	41	0.40	52	0.51
		1.25	9 - 0805 - LE	9.4	29	0.31	35	0.38	47	0.50	63	0.67
		1.5	9 - 0806 - LE	7.8	29	0.38	35	0.45	47	0.60	67	0.87
		1.75	9 - 0807 - LE	6.9	30	0.44	36	0.53	48	0.70	68	0.98
		2	9 - 0808 - LE	6.5	33	0.50	39	0.60	52	0.80	74	1.14
		2.5	9 - 0810 - LE	5.3	33	0.63	40	0.75	53	1.00	77	1.46
		3	9 - 0812 - LE	4.1	30	0.75	36	0.90	49	1.20	75	1.85
		3.5	9 - 0814 - LE	3.1	27	0.88	32	1.05	43	1.40	66	2.13
		4.5	9 - 0818 - LE	2.5	28	1.13	34	1.35	45	1.80	71	2.83
		5.5	9 - 0822 - LE	2.1	29	1.38	35	1.65	46	2.20	76	3.58
		6.5	9 - 0826 - LE	1.5	24	1.63	29	1.95	39	2.60	58	3.90
		7.5	9 - 0830 - LE	1.1	21	1.88	26	2.25	34	3.00	50	4.37
12	9 - 0848 - LE	0.8	24	3.00	29	3.60	38	4.80	58	7.24		
5/8	11/32	1	9 - 1004 - LE	13.4	33	0.25	40	0.30	53	0.40	58	0.43
		1.25	9 - 1005 - LE	13.1	41	0.31	49	0.38	65	0.50	87	0.67
		1.5	9 - 1006 - LE	11.0	41	0.38	50	0.45	66	0.60	87	0.79
		1.75	9 - 1007 - LE	9.8	43	0.44	51	0.53	68	0.70	92	0.94
		2	9 - 1008 - LE	9.0	45	0.50	54	0.60	72	0.80	102	1.14
		2.5	9 - 1010 - LE	6.1	38	0.63	46	0.75	61	1.00	89	1.46
		3	9 - 1012 - LE	5.7	43	0.75	51	0.90	68	1.20	94	1.65
		3.5	9 - 1014 - LE	4.9	43	0.88	52	1.05	69	1.40	99	2.01
		4	9 - 1016 - LE	4.5	45	1.00	53	1.20	71	1.60	109	2.44
		12	9 - 1048 - LE	1.4	43	3.00	51	3.60	68	4.80	102	7.13
3/4	3/8	1	9 - 1204 - L	31.7	79	0.25	95	0.30	127	0.40	162	0.51
		1.25	9 - 1205 - L	24.4	76	0.31	91	0.38	122	0.50	154	0.63
		1.5	9 - 1206 - L	19.3	73	0.38	87	0.45	116	0.60	145	0.75
		1.75	9 - 1207 - L	16.3	71	0.44	85	0.53	114	0.70	147	0.91
		2	9 - 1208 - L	14.1	70	0.50	85	0.60	113	0.80	144	1.02
		2.5	9 - 1210 - L	11.0	69	0.63	82	0.75	110	1.00	139	1.26
		3	9 - 1212 - L	9.2	69	0.75	83	0.90	110	1.20	145	1.57
		3.5	9 - 1214 - L	7.7	67	0.88	81	1.05	107	1.40	139	1.81
		4	9 - 1216 - L	6.7	67	1.00	81	1.20	108	1.60	141	2.09
		4.5	9 - 1218 - L	5.9	67	1.13	80	1.35	107	1.80	140	2.36
		5	9 - 1220 - L	5.4	67	1.25	80	1.50	107	2.00	142	2.64
		5.5	9 - 1222 - L	4.8	67	1.38	80	1.65	107	2.20	139	2.87
		6	9 - 1224 - L	4.5	67	1.50	81	1.80	108	2.40	143	3.19
		12	9 - 1248 - L	2.2	65	3.00	78	3.60	104	4.80	138	6.38
1	1/2	1	9 - 1604 - L	57.1	143	0.25	171	0.30	228	0.40	292	0.51
		1.25	9 - 1605 - L	46.0	144	0.31	172	0.38	230	0.50	290	0.63
		1.5	9 - 1606 - L	37.0	139	0.38	166	0.45	222	0.60	277	0.75
		1.75	9 - 1607 - L	30.4	133	0.44	160	0.53	213	0.70	275	0.91
		2	9 - 1608 - L	26.4	132	0.50	158	0.60	211	0.80	260	0.98
		2.5	9 - 1610 - L	20.4	127	0.63	153	0.75	204	1.00	249	1.22
		3	9 - 1612 - L	16.7	125	0.75	150	0.90	200	1.20	256	1.54
		3.5	9 - 1614 - L	14.2	124	0.88	149	1.05	198	1.40	256	1.81
		4	9 - 1616 - L	12.1	121	1.00	145	1.20	194	1.60	248	2.05
		4.5	9 - 1618 - L	10.7	120	1.13	144	1.35	193	1.80	248	2.32
		5	9 - 1620 - L	9.6	119	1.25	143	1.50	191	2.00	248	2.60
		5.5	9 - 1622 - L	8.7	119	1.38	143	1.65	191	2.20	253	2.91
		6	9 - 1624 - L	7.9	119	1.50	143	1.80	190	2.40	250	3.15
		7	9 - 1628 - L	6.8	119	1.75	143	2.10	190	2.80	249	3.66
		8	9 - 1632 - L	6.0	120	2.00	144	2.40	192	3.20	253	4.21
		12	9 - 1648 - L	4.0	120	3.00	144	3.60	191	4.80	251	6.30

Sizes: 1 1/4" to 2 1/2", Rectangular Wire Construction  
 Sizes: 3/8" to 5/8", Round Wire Construction

Color: Green

INCH

Hole Dia. in.	Rod Dia. in.	Free Length in.	CATALOG NUMBER	RATE Pounds Required to Deflect 1/10 in.	LOAD - DEFLECTION TABLE									
					Total Deflection Recommended for Long Life (25% of C)		Total Deflection Recommended for Average Life (30% of C)		Maximum Operating Deflection (40% of C)		Total Travel to Solid			
					Load lbs.	Deflection inches	Load lbs.	Deflection inches	Load lbs.	Deflection inches	Load lbs.	Deflection inches		
A	B	C												
1 1/4	5/8	1.5	9 - 2006 - L	53.6	201	0.38	241	0.45	322	0.60	401	0.75		
		1.75	9 - 2007 - L	45.4	199	0.44	238	0.53	318	0.70	393	0.87		
		2	9 - 2008 - L	38.2	191	0.50	229	0.60	306	0.80	376	0.98		
		2.5	9 - 2010 - L	31.4	196	0.63	235	0.75	314	1.00	395	1.26		
		3	9 - 2012 - L	26.3	197	0.75	236	0.90	315	1.20	403	1.54		
		3.5	9 - 2014 - L	21.2	186	0.88	223	1.05	297	1.40	376	1.77		
		4	9 - 2016 - L	18.3	183	1.00	219	1.20	292	1.60	374	2.05		
		4.5	9 - 2018 - L	16.9	190	1.13	228	1.35	304	1.80	386	2.28		
		5	9 - 2020 - L	14.3	178	1.25	214	1.50	285	2.00	365	2.56		
		5.5	9 - 2022 - L	13.4	184	1.38	221	1.65	295	2.20	380	2.83		
		6	9 - 2024 - L	12.3	184	1.50	221	1.80	295	2.40	378	3.07		
		7	9 - 2028 - L	10.4	182	1.75	218	2.10	291	2.80	360	3.46		
8	9 - 2032 - L	9.1	181	2.00	217	2.40	290	3.20	371	4.09				
10	9 - 2040 - L	7.2	180	2.50	216	3.00	288	4.00	368	5.12				
12	9 - 2048 - L	5.9	178	3.00	213	3.60	284	4.80	361	6.10				
1 1/2	3/4	2	9 - 2408 - L	52.5	263	0.50	315	0.60	420	0.80	517	0.98		
		2.5	9 - 2410 - L	41.6	260	0.63	312	0.75	416	1.00	524	1.26		
		3	9 - 2412 - L	36.0	270	0.75	324	0.90	431	1.20	538	1.50		
		3.5	9 - 2414 - L	29.1	255	0.88	306	1.05	408	1.40	516	1.77		
		4	9 - 2416 - L	24.5	245	1.00	295	1.20	393	1.60	493	2.01		
		4.5	9 - 2418 - L	22.6	254	1.13	305	1.35	407	1.80	516	2.28		
		5	9 - 2420 - L	21.1	264	1.25	317	1.50	422	2.00	540	2.56		
		5.5	9 - 2422 - L	18.3	251	1.38	301	1.65	402	2.20	511	2.80		
		6	9 - 2424 - L	16.0	240	1.50	288	1.80	384	2.40	491	3.07		
		7	9 - 2428 - L	14.4	252	1.75	302	2.10	403	2.80	521	3.62		
		8	9 - 2432 - L	13.0	259	2.00	311	2.40	415	3.20	536	4.13		
		10	9 - 2440 - L	9.7	243	2.50	291	3.00	388	4.00	500	5.16		
12	9 - 2448 - L	8.5	254	3.00	304	3.60	406	4.80	523	6.18				
2	1	2.5	9 - 3210 - L	89.7	560	0.63	672	0.75	897	1.00	1130	1.26		
		3	9 - 3212 - L	72.0	540	0.75	648	0.90	864	1.20	1105	1.54		
		3.5	9 - 3214 - L	60.0	525	0.88	630	1.05	841	1.40	1064	1.77		
		4	9 - 3216 - L	51.3	513	1.00	615	1.20	820	1.60	1049	2.05		
		4.5	9 - 3218 - L	43.8	492	1.13	591	1.35	788	1.80	1000	2.28		
		5	9 - 3220 - L	40.0	500	1.25	600	1.50	800	2.00	1023	2.56		
		5.5	9 - 3222 - L	36.0	495	1.38	594	1.65	792	2.20	1020	2.83		
		6	9 - 3224 - L	32.8	492	1.50	590	1.80	787	2.40	1007	3.07		
		7	9 - 3228 - L	27.8	486	1.75	584	2.10	778	2.80	1006	3.62		
		8	9 - 3232 - L	23.7	474	2.00	569	2.40	758	3.20	970	4.09		
		10	9 - 3240 - L	18.8	470	2.50	564	3.00	752	4.00	962	5.12		
		12	9 - 3248 - L	15.5	465	3.00	558	3.60	744	4.80	952	6.14		
2 1/2	1 1/2	3	9 - 4012 - L	110	825	0.75	990	0.90	1319	1.20	1645	1.50		
		3.5	9 - 4014 - L	90.1	789	0.88	946	1.05	1262	1.40	1561	1.73		
		4	9 - 4016 - L	76.4	764	1.00	916	1.20	1222	1.60	1503	1.97		
		4.5	9 - 4018 - L	66.2	744	1.13	893	1.35	1191	1.80	1485	2.24		
		5	9 - 4020 - L	58.0	725	1.25	870	1.50	1160	2.00	1461	2.52		
		6	9 - 4024 - L	47.7	716	1.50	859	1.80	1145	2.40	1428	2.99		
		7	9 - 4028 - L	40.1	701	1.75	842	2.10	1122	2.80	1404	3.50		
		8	9 - 4032 - L	34.5	690	2.00	828	2.40	1103	3.20	1385	4.02		
		10	9 - 4040 - L	26.8	670	2.50	804	3.00	1072	4.00	1329	4.96		
		12	9 - 4048 - L	22.1	663	3.00	795	3.60	1060	4.80	1322	5.98		
		<b>Round Wire Construction</b>												
		3/8	3/16	1	9 - 0604 - L	2.6	7	0.25	8	0.30	11	0.40	13	0.51
1.25	9 - 0605 - L			2.0	6	0.31	7	0.38	10	0.50	13	0.63		
1.5	9 - 0606 - L			1.6	6	0.38	7	0.45	10	0.60	13	0.79		
1.75	9 - 0607 - L			1.4	6	0.44	7	0.53	10	0.70	12	0.91		
2	9 - 0608 - L			1.2	6	0.50	7	0.60	10	0.80	13	1.06		
2.5	9 - 0610 - L			1.0	6	0.63	7	0.75	10	1.00	13	1.34		
3	9 - 0612 - L			0.8	6	0.75	7	0.90	9	1.20	12	1.57		
12	9 - 0648 - L			0.2	5	3.00	6	3.60	9	4.80	12	6.42		
1/2	9/32	1	9 - 0804 - L	5.1	13	0.25	15	0.30	21	0.40	26	0.51		
		1.25	9 - 0805 - L	3.8	12	0.31	14	0.38	19	0.50	26	0.67		
		1.5	9 - 0806 - L	3.1	12	0.38	14	0.45	18	0.60	24	0.79		
		1.75	9 - 0807 - L	2.6	11	0.44	14	0.53	18	0.70	24	0.91		
		2	9 - 0808 - L	2.2	11	0.50	13	0.60	18	0.80	23	1.06		
		2.5	9 - 0810 - L	1.7	11	0.63	13	0.75	17	1.00	24	1.38		
		3	9 - 0812 - L	1.4	11	0.75	13	0.90	17	1.20	23	1.61		
		3.5	9 - 0814 - L	1.2	10	0.88	13	1.05	17	1.40	23	1.93		
12	9 - 0848 - L	0.3	10	3.00	12	3.60	16	4.80	22	6.54				
5/8	11/32	1	9 - 1004 - L	10.2	25	0.25	30	0.30	41	0.40	52	0.51		
		1.25	9 - 1005 - L	7.6	24	0.31	29	0.38	38	0.50	48	0.63		
		1.5	9 - 1006 - L	6.0	23	0.38	27	0.45	36	0.60	47	0.79		
		1.75	9 - 1007 - L	5.0	22	0.44	26	0.53	35	0.70	45	0.91		
		2	9 - 1008 - L	4.3	22	0.50	26	0.60	35	0.80	46	1.06		
		2.5	9 - 1010 - L	3.4	21	0.63	25	0.75	34	1.00	45	1.34		
		3	9 - 1012 - L	2.7	20	0.75	25	0.90	33	1.20	44	1.61		
		3.5	9 - 1014 - L	2.3	20	0.88	25	1.05	33	1.40	45	1.93		
		4	9 - 1016 - L	2.0	20	1.00	24	1.20	32	1.60	44	2.20		
		12	9 - 1048 - L	0.6	19	3.00	23	3.60	31	4.80	43	6.69		

**MEDIUM LOAD**

Vacuum degassed,  
valve spring quality alloy steel

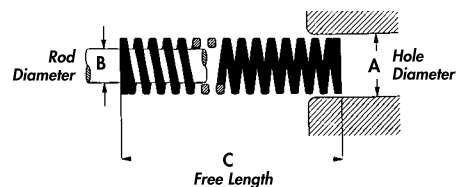

Sizes: 3/8" to 1", Rectangular Wire Construction

Color: Blue

Hole Dia. in.	Rod Dia. in.	Free Length in.	CATALOG NUMBER	RATE Pounds Required to Deflect 1/10 in.	LOAD - DEFLECTION TABLE							
					Total Deflection Recommended for Long Life (25% of C)		Total Deflection Recommended for Average Life (30% of C)		Maximum Operating Deflection (37.5% of C)		Total Travel to Solid	
					Load lbs.	Deflection inches	Load lbs.	Deflection inches	Load lbs.	Deflection inches	Load lbs.	Deflection inches
<b>Rectangular Wire Construction</b>												
3/8	3/16	1	9 - 0604 - ME	9.1	23	0.25	27	0.30	34	0.38	40	0.43
		1 1/4	9 - 0605 - ME	7.4	23	0.31	28	0.38	35	0.47	53	0.71
		1 1/2	9 - 0606 - ME	6.8	25	0.38	31	0.45	38	0.56	53	0.79
		1 3/4	9 - 0607 - ME	5.9	26	0.44	31	0.53	39	0.66	51	0.87
		2	9 - 0608 - ME	5.1	25	0.50	30	0.60	38	0.75	52	1.02
		2 1/2	9 - 0610 - ME	4.3	27	0.63	32	0.75	40	0.94	54	1.26
		3	9 - 0612 - ME	3.0	23	0.75	27	0.90	34	1.13	45	1.50
		12	9 - 0648 - ME	0.9	27	3.00	33	3.60	41	4.50	54	5.87
1/2	9/32	1	9 - 0804 - ME	17.1	43	0.25	51	0.30	64	0.38	88	0.51
		1 1/4	9 - 0805 - ME	14.2	44	0.31	53	0.38	66	0.47	100	0.71
		1 1/2	9 - 0806 - ME	12.2	46	0.38	55	0.45	69	0.56	96	0.79
		1 3/4	9 - 0807 - ME	10.6	46	0.44	55	0.53	69	0.66	100	0.94
		2	9 - 0808 - ME	8.8	44	0.50	53	0.60	66	0.75	98	1.10
		2 1/2	9 - 0810 - ME	6.9	43	0.63	52	0.75	65	0.94	95	1.38
		3	9 - 0812 - ME	5.8	44	0.75	52	0.90	65	1.13	94	1.61
		3 1/2	9 - 0814 - ME	4.8	42	0.88	50	1.05	63	1.31	92	1.93
12	9 - 0848 - ME	1.2	36	3.00	43	3.60	54	4.50	70	5.87		
5/8	11/32	1	9 - 1004 - ME	28.2	70	0.25	85	0.30	106	0.38	133	0.47
		1 1/4	9 - 1005 - ME	21.2	66	0.31	79	0.38	99	0.47	125	0.59
		1 1/2	9 - 1006 - ME	19.3	73	0.38	87	0.45	109	0.56	145	0.75
		1 3/4	9 - 1007 - ME	17.1	75	0.44	90	0.53	112	0.66	142	0.83
		2	9 - 1008 - ME	15.1	75	0.50	90	0.60	113	0.75	148	0.98
		2 1/2	9 - 1010 - ME	11.7	73	0.63	88	0.75	110	0.94	147	1.26
		3	9 - 1012 - ME	10.2	76	0.75	91	0.90	114	1.13	156	1.54
		3 1/2	9 - 1014 - ME	8.7	76	0.88	91	1.05	114	1.31	154	1.77
4	9 - 1016 - ME	7.7	77	1.00	92	1.20	116	1.50	161	2.09		
12	9 - 1048 - ME	2.7	82	3.00	99	3.60	123	4.50	162	5.91		
3/4	3/8	1	9 - 1204 - M	51.5	129	0.25	155	0.30	193	0.38	223	0.43
		1 1/4	9 - 1205 - M	39.0	122	0.31	146	0.38	183	0.47	200	0.51
		1 1/2	9 - 1206 - M	31.4	118	0.38	142	0.45	177	0.56	198	0.63
		1 3/4	9 - 1207 - M	25.7	112	0.44	135	0.53	169	0.66	192	0.75
		2	9 - 1208 - M	22.2	111	0.50	133	0.60	167	0.75	184	0.83
		2 1/2	9 - 1210 - M	17.4	108	0.63	130	0.75	163	0.94	184	1.06
		3	9 - 1212 - M	14.2	106	0.75	127	0.90	159	1.13	184	1.30
		3 1/2	9 - 1214 - M	12.2	106	0.88	128	1.05	160	1.31	187	1.54
		4	9 - 1216 - M	10.6	106	1.00	127	1.20	159	1.50	184	1.73
		4 1/2	9 - 1218 - M	9.3	105	1.13	126	1.35	157	1.69	180	1.93
		5	9 - 1220 - M	8.4	105	1.25	126	1.50	157	1.88	182	2.17
		5 1/2	9 - 1222 - M	7.6	104	1.38	125	1.65	157	2.06	182	2.40
		6	9 - 1224 - M	6.8	103	1.50	123	1.80	154	2.25	178	2.60
		12	9 - 1248 - M	3.5	104	3.00	125	3.60	156	4.50	185	5.35
1	1/2	1	9 - 1604 - M	86.0	215	0.25	258	0.30	323	0.38	372	0.43
		1 1/4	9 - 1605 - M	67.6	211	0.31	254	0.38	317	0.47	346	0.51
		1 1/2	9 - 1606 - M	53.3	200	0.38	240	0.45	300	0.56	336	0.63
		1 3/4	9 - 1607 - M	47.5	208	0.44	249	0.53	312	0.66	355	0.75
		2	9 - 1608 - M	39.3	197	0.50	236	0.60	295	0.75	325	0.83
		2 1/2	9 - 1610 - M	30.4	190	0.63	228	0.75	285	0.94	323	1.06
		3	9 - 1612 - M	24.7	185	0.75	222	0.90	278	1.13	321	1.30
		3 1/2	9 - 1614 - M	21.7	190	0.88	228	1.05	285	1.31	333	1.54
		4	9 - 1616 - M	18.8	188	1.00	226	1.20	283	1.50	326	1.73
		4 1/2	9 - 1618 - M	16.7	188	1.13	226	1.35	282	1.69	329	1.97
		5	9 - 1620 - M	15.1	188	1.25	226	1.50	283	1.88	332	2.20
		5 1/2	9 - 1622 - M	13.6	187	1.38	224	1.65	280	2.06	337	2.48
		6	9 - 1624 - M	12.4	187	1.50	224	1.80	280	2.25	328	2.64
		7	9 - 1628 - M	10.6	185	1.75	222	2.10	277	2.63	328	3.11
8	9 - 1632 - M	9.1	182	2.00	219	2.40	273	3.00	323	3.54		
12	9 - 1648 - M	6.0	179	3.00	215	3.60	269	4.50	317	5.31		





## HEAVY LOAD

Vacuum degassed,  
valve spring quality alloy steel

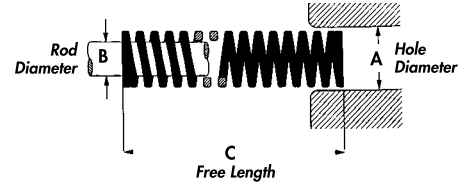

Sizes: 3/8" to 1", Rectangular Wire Construction

Color: Red

Hole Dia. in.	Rod Dia. in.	Free Length in.	CATALOG NUMBER	RATE Pounds Required to Deflect 1/10 in.	LOAD - DEFLECTION TABLE							
					Total Deflection Recommended for Long Life (20% of C)		Total Deflection Recommended for Average Life (25% of C)		Maximum Operating Deflection (30% of C)		Total Travel to Solid	
					Load lbs.	Deflection inches	Load lbs.	Deflection inches	Load lbs.	Deflection inches	Load lbs.	Deflection inches
A	B	C										
<b>Rectangular Wire Construction</b>												
3/8	3/16	1	9-0604-HE	12.6	25	0.20	32	0.25	38	0.30	60	0.47
		1 1/4	9-0605-HE	10.0	25	0.25	31	0.31	37	0.38	51	0.51
		1 1/2	9-0606-HE	9.8	29	0.30	37	0.38	44	0.45	58	0.59
		1 3/4	9-0607-HE	8.6	30	0.35	37	0.44	45	0.53	64	0.75
		2	9-0608-HE	7.3	29	0.40	37	0.50	44	0.60	66	0.91
		2 1/2	9-0610-HE	6.1	31	0.50	38	0.63	46	0.75	65	1.06
		3	9-0612-HE	4.3	26	0.60	32	0.75	39	0.90	54	1.26
		12	9-0648-HE	1.2	29	2.40	36	3.00	43	3.60	66	5.51
1/2	9/32	1	9-0804-HE	24.0	48	0.20	60	0.25	72	0.30	114	0.47
		1 1/4	9-0805-HE	18.9	47	0.25	59	0.31	71	0.38	119	0.63
		1 1/2	9-0806-HE	16.7	50	0.30	63	0.38	75	0.45	132	0.79
		1 3/4	9-0807-HE	14.0	49	0.35	61	0.44	74	0.53	122	0.87
		2	9-0808-HE	11.2	45	0.40	56	0.50	67	0.60	110	0.98
		2 1/2	9-0810-HE	8.6	43	0.50	54	0.63	64	0.75	101	1.18
		3	9-0812-HE	7.5	45	0.60	57	0.75	68	0.90	110	1.46
		3 1/2	9-0814-HE	6.5	46	0.70	57	0.88	68	1.05	108	1.65
		12	9-0848-HE	1.6	38	2.40	48	3.00	58	3.60	82	5.12
5/8	11/32	1	9-1004-HE	43.2	86	0.20	108	0.25	130	0.30	170	0.39
		1 1/4	9-1005-HE	30.1	75	0.25	94	0.31	113	0.38	154	0.51
		1 1/2	9-1006-HE	27.7	83	0.30	104	0.38	125	0.45	185	0.67
		1 3/4	9-1007-HE	24.4	85	0.35	107	0.44	128	0.53	202	0.83
		2	9-1008-HE	21.2	85	0.40	106	0.50	127	0.60	192	0.91
		2 1/2	9-1010-HE	17.3	86	0.50	108	0.63	130	0.75	197	1.14
		3	9-1012-HE	14.7	88	0.60	110	0.75	132	0.90	196	1.34
		3 1/2	9-1014-HE	12.4	87	0.70	108	0.88	130	1.05	190	1.54
				4	9-1016-HE	11.0	88	0.80	110	1.00	132	1.20
		12	9-1048-HE	4.1	97	2.40	122	3.00	146	3.60	185	4.57
3/4	3/8	1	9-1204-H	123	247	0.20	308	0.25	370	0.30	388	0.31
		1 1/4	9-1205-H	95.9	240	0.25	300	0.31	360	0.38	377	0.39
		1 1/2	9-1206-H	73.6	221	0.30	276	0.38	331	0.45	348	0.47
		1 3/4	9-1207-H	63.9	224	0.35	280	0.44	336	0.53	352	0.55
		2	9-1208-H	53.6	215	0.40	268	0.50	322	0.60	338	0.63
		2 1/2	9-1210-H	41.2	206	0.50	257	0.63	309	0.75	340	0.83
		3	9-1212-H	34.1	204	0.60	256	0.75	307	0.90	349	1.02
		3 1/2	9-1214-H	28.8	202	0.70	252	0.88	303	1.05	340	1.18
		4	9-1216-H	25.2	202	0.80	252	1.00	303	1.20	348	1.38
		4 1/2	9-1218-H	21.9	197	0.90	247	1.13	296	1.35	345	1.57
		5	9-1220-H	19.5	195	1.00	243	1.25	292	1.50	337	1.73
		5 1/2	9-1222-H	17.7	195	1.10	243	1.38	292	1.65	341	1.93
		6	9-1224-H	16.1	193	1.20	241	1.50	290	1.80	336	2.09
		12	9-1248-H	8.6	205	2.40	257	3.00	308	3.60	364	4.25
1	1/2	1	9-1604-H	217	434	0.20	543	0.25	651	0.30	684	0.31
		1 1/4	9-1605-H	158	394	0.25	493	0.31	591	0.38	621	0.39
		1 1/2	9-1606-H	125	376	0.30	470	0.38	564	0.45	642	0.51
		1 3/4	9-1607-H	105	369	0.35	461	0.44	553	0.53	622	0.59
		2	9-1608-H	89.8	359	0.40	449	0.50	539	0.60	636	0.71
		2 1/2	9-1610-H	69.4	347	0.50	434	0.63	521	0.75	601	0.87
		3	9-1612-H	57.1	343	0.60	428	0.75	514	0.90	607	1.06
		3 1/2	9-1614-H	48.2	337	0.70	421	0.88	506	1.05	626	1.30
		4	9-1616-H	41.9	336	0.80	419	1.00	503	1.20	611	1.46
		4 1/2	9-1618-H	37.2	335	0.90	419	1.13	502	1.35	630	1.69
		5	9-1620-H	32.8	328	1.00	410	1.25	492	1.50	607	1.85
		5 1/2	9-1622-H	29.7	327	1.10	409	1.38	491	1.65	609	2.05
		6	9-1624-H	27.4	329	1.20	411	1.50	493	1.80	615	2.24
7	9-1628-H	23.3	327	1.40	409	1.75	490	2.10	625	2.68		
8	9-1632-H	20.4	326	1.60	408	2.00	489	2.40	618	3.03		
		12	9-1648-H	13.1	314	2.40	392	3.00	471	3.60	592	4.53



Sizes: 1 1/4" to 2", Rectangular Wire Construction  
 Sizes: 3/8" to 5/8", Round Wire Construction

Color: Red

Hole Dia. in.	Rod Dia. in.	Free Length in.	CATALOG NUMBER	RATE Pounds Required to Deflect 1/10 in.	LOAD - DEFLECTION TABLE							
					Total Deflection Recommended for Long Life (20% of C)		Total Deflection Recommended for Average Life (25% of C)		Maximum Operating Deflection (30% of C)		Total Travel to Solid	
					Load lbs.	Deflection inches	Load lbs.	Deflection inches	Load lbs.	Deflection inches	Load lbs.	Deflection inches
A	B	C										
1 1/4	5/8	1 1/2	9-2006-H	215	644	0.30	805	0.38	966	0.45	1014	0.47
		1 3/4	9-2007-H	177	618	0.35	773	0.44	928	0.53	974	0.55
		2	9-2008-H	150	601	0.40	751	0.50	902	0.60	947	0.63
		2 1/2	9-2010-H	117	584	0.50	730	0.63	876	0.75	965	0.83
		3	9-2012-H	94.7	568	0.60	711	0.75	853	0.90	970	1.02
		3 1/2	9-2014-H	80.2	561	0.70	701	0.88	842	1.05	947	1.18
		4	9-2016-H	69.1	553	0.80	691	1.00	829	1.20	952	1.38
		4 1/2	9-2018-H	60.8	547	0.90	684	1.13	820	1.35	957	1.57
		5	9-2020-H	54.7	547	1.00	683	1.25	820	1.50	969	1.77
		5 1/2	9-2022-H	49.3	542	1.10	678	1.38	814	1.65	971	1.97
		6	9-2024-H	44.9	539	1.20	674	1.50	809	1.80	955	2.13
		7	9-2028-H	38.1	533	1.40	666	1.75	800	2.10	945	2.48
8	9-2032-H	33.0	529	1.60	661	2.00	793	2.40	937	2.83		
10	9-2040-H	26.4	529	2.00	661	2.50	793	3.00	957	3.62		
12	9-2048-H	21.8	523	2.40	654	3.00	784	3.60	944	4.33		
1 1/2	3/4	2	9-2408-H	201	804	0.40	1006	0.50	1207	0.60	1346	0.67
		2 1/2	9-2410-H	153	766	0.50	957	0.63	1149	0.75	1327	0.87
		3	9-2412-H	125	750	0.60	938	0.75	1125	0.90	1329	1.06
		3 1/2	9-2414-H	105	738	0.70	923	0.88	1107	1.05	1329	1.26
		4	9-2416-H	90.7	726	0.80	907	1.00	1088	1.20	1321	1.46
		4 1/2	9-2418-H	80.4	724	0.90	905	1.13	1086	1.35	1330	1.65
		5	9-2420-H	71.5	715	1.00	893	1.25	1072	1.50	1322	1.85
		5 1/2	9-2422-H	64.3	708	1.10	884	1.38	1061	1.65	1317	2.05
		6	9-2424-H	59.1	709	1.20	886	1.50	1063	1.80	1326	2.24
		7	9-2428-H	50.3	704	1.40	880	1.75	1056	2.10	1326	2.64
		8	9-2432-H	43.8	700	1.60	876	2.00	1051	2.40	1310	2.99
		10	9-2440-H	34.5	691	2.00	863	2.50	1036	3.00	1319	3.82
12	9-2448-H	28.7	688	2.40	860	3.00	1031	3.60	1308	4.57		
2	1	2 1/2	9-3210-H	242	1209	0.50	1512	0.63	1814	0.75	2000	0.83
		3	9-3212-H	193	1158	0.60	1448	0.75	1737	0.90	1976	1.02
		3 1/2	9-3214-H	161	1124	0.70	1405	0.88	1686	1.05	1896	1.18
		4	9-3216-H	140	1119	0.80	1398	1.00	1678	1.20	1927	1.38
		4 1/2	9-3218-H	123	1104	0.90	1380	1.13	1657	1.35	1932	1.57
		5	9-3220-H	108	1080	1.00	1351	1.25	1621	1.50	1914	1.77
		5 1/2	9-3222-H	96.5	1061	1.10	1326	1.38	1592	1.65	1899	1.97
		6	9-3224-H	88.1	1057	1.20	1321	1.50	1585	1.80	1872	2.13
		7	9-3228-H	75.1	1051	1.40	1314	1.75	1576	2.10	1891	2.52
		8	9-3232-H	65.8	1053	1.60	1316	2.00	1579	2.40	1865	2.83
		10	9-3240-H	51.6	1032	2.00	1290	2.50	1548	3.00	1869	3.62
		12	9-3248-H	42.6	1023	2.40	1279	3.00	1535	3.60	1880	4.41
<b>Round Wire Construction</b>												
3/8	3/16	1	9-0604-H	12.2	24	0.20	30	0.25	37	0.30	43	0.35
		1 1/4	9-0605-H	9.4	23	0.25	29	0.31	35	0.38	44	0.47
		1 1/2	9-0606-H	7.6	23	0.30	28	0.38	34	0.45	42	0.55
		1 3/4	9-0607-H	6.7	23	0.35	29	0.44	35	0.53	45	0.67
		2	9-0608-H	5.6	22	0.40	28	0.50	34	0.60	42	0.75
		2 1/2	9-0610-H	4.4	22	0.50	27	0.63	33	0.75	43	0.98
		3	9-0612-H	3.6	22	0.60	27	0.75	32	0.90	41	1.14
		12	9-0648-H	0.9	21	2.40	26	3.00	31	3.60	41	4.72
1/2	9/32	1	9-0804-H	22.5	45	0.20	56	0.25	67	0.30	80	0.35
		1 1/4	9-0805-H	17.2	43	0.25	54	0.31	64	0.38	74	0.43
		1 1/2	9-0806-H	13.8	41	0.30	52	0.38	62	0.45	71	0.51
		1 3/4	9-0807-H	11.5	40	0.35	50	0.44	60	0.53	72	0.63
		2	9-0808-H	10.1	40	0.40	50	0.50	61	0.60	76	0.75
		2 1/2	9-0810-H	7.9	39	0.50	49	0.63	59	0.75	75	0.94
		3	9-0812-H	6.5	39	0.60	49	0.75	58	0.90	74	1.14
		3 1/2	9-0814-H	5.5	38	0.70	48	0.88	58	1.05	71	1.30
12	9-0848-H	1.5	37	2.40	46	3.00	55	3.60	72	4.72		
5/8	11/32	1	9-1004-H	49.6	99	0.20	124	0.25	149	0.30	176	0.35
		1 1/4	9-1005-H	36.4	91	0.25	114	0.31	136	0.38	157	0.43
		1 1/2	9-1006-H	29.5	89	0.30	111	0.38	133	0.45	163	0.55
		1 3/4	9-1007-H	24.0	84	0.35	105	0.44	126	0.53	151	0.63
		2	9-1008-H	20.9	84	0.40	104	0.50	125	0.60	148	0.71
		2 1/2	9-1010-H	16.2	81	0.50	101	0.63	121	0.75	146	0.91
		3	9-1012-H	13.2	79	0.60	99	0.75	119	0.90	151	1.14
		3 1/2	9-1014-H	11.2	79	0.70	98	0.88	118	1.05	151	1.34
		4	9-1016-H	9.8	78	0.80	98	1.00	118	1.20	154	1.57
		12	9-1048-H	3.1	74	2.40	93	3.00	112	3.60	149	4.80

INCH



## EXTRA HEAVY LOAD

Vacuum degassed,  
valve spring quality alloy steel

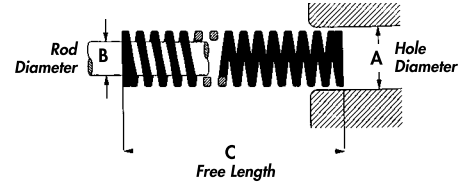

Sizes: 3/8" to 1", Rectangular Wire Construction

Color: Yellow

Hole Dia. in.	Rod Dia. in.	Free Length in.	CATALOG NUMBER	RATE Pounds Required to Deflect 1/10 in.	LOAD - DEFLECTION TABLE							
					Total Deflection Recommended for Long Life (17% of C)		Total Deflection Recommended for Average Life (20% of C)		Maximum Operating Deflection (25% of C)		Total Travel to Solid	
					Load lbs.	Deflection inches	Load lbs.	Deflection inches	Load lbs.	Deflection inches	Load lbs.	Deflection inches
3/8	3/16	1	9-0604-X	18.5	32	0.17	37	0.20	46	0.25	66	0.35
		1 1/4	9-0605-X	14.3	30	0.21	36	0.25	45	0.31	56	0.39
		1 1/2	9-0606-X	11.9	30	0.26	36	0.30	45	0.38	61	0.51
		1 3/4	9-0607-X	10.2	30	0.30	36	0.35	45	0.44	60	0.59
		2	9-0608-X	8.6	29	0.34	34	0.40	43	0.50	57	0.67
		2 1/2	9-0610-X	6.8	29	0.43	34	0.50	43	0.63	57	0.83
		3	9-0612-X	5.7	29	0.51	34	0.60	43	0.75	58	1.02
		12	9-0648-X	1.4	28	2.04	33	2.40	41	3.00	57	4.17
1/2	9/32	1	9-0804-X	33.3	57	0.17	67	0.20	83	0.25	118	0.35
		1 1/4	9-0805-X	25.3	54	0.21	63	0.25	79	0.31	110	0.43
		1 1/2	9-0806-X	20.5	52	0.26	62	0.30	77	0.38	105	0.51
		1 3/4	9-0807-X	17.6	52	0.30	62	0.35	77	0.44	104	0.59
		2	9-0808-X	15.4	52	0.34	62	0.40	77	0.50	109	0.71
		2 1/2	9-0810-X	12.3	52	0.43	62	0.50	77	0.63	107	0.87
		3	9-0812-X	10.2	52	0.51	61	0.60	76	0.75	108	1.06
		3 1/2	9-0814-X	8.7	52	0.60	61	0.70	76	0.88	113	1.30
12	9-0848-X	2.5	50	2.04	59	2.40	74	3.00	108	4.41		
5/8	11/32	1	9-1004-X	71.6	122	0.17	143	0.20	179	0.25	254	0.35
		1 1/4	9-1005-X	53.0	113	0.21	132	0.25	166	0.31	229	0.43
		1 1/2	9-1006-X	42.7	109	0.26	128	0.30	160	0.38	219	0.51
		1 3/4	9-1007-X	36.0	107	0.30	126	0.35	157	0.44	212	0.59
		2	9-1008-X	31.4	107	0.34	126	0.40	157	0.50	223	0.71
		2 1/2	9-1010-X	24.5	104	0.43	122	0.50	153	0.63	212	0.87
		3	9-1012-X	20.1	103	0.51	121	0.60	151	0.75	206	1.02
		3 1/2	9-1014-X	17.0	101	0.60	119	0.70	149	0.88	208	1.22
4	9-1016-X	14.9	101	0.68	119	0.80	149	1.00	211	1.42		
12	9-1048-X	4.9	100	2.04	117	2.40	146	3.00	211	4.33		
3/4	3/8	1	9-1204-X	167	284	0.17	334	0.20	418	0.25	527	0.31
		1 1/4	9-1205-X	128	272	0.21	320	0.25	400	0.31	503	0.39
		1 1/2	9-1206-X	101	258	0.26	303	0.30	379	0.38	477	0.47
		1 3/4	9-1207-X	85.0	253	0.30	298	0.35	372	0.44	469	0.55
		2	9-1208-X	73.1	248	0.34	292	0.40	365	0.50	460	0.63
		2 1/2	9-1210-X	56.5	240	0.43	283	0.50	353	0.63	467	0.83
		3	9-1212-X	46.6	238	0.51	280	0.60	350	0.75	459	0.98
		3 1/2	9-1214-X	39.7	236	0.60	278	0.70	347	0.88	468	1.18
		4	9-1216-X	34.6	235	0.68	277	0.80	346	1.00	463	1.34
		4 1/2	9-1218-X	30.2	231	0.77	272	0.90	340	1.13	453	1.50
		5	9-1220-X	27.2	231	0.85	272	1.00	340	1.25	460	1.69
		5 1/2	9-1222-X	24.5	229	0.94	270	1.10	337	1.38	454	1.85
6	9-1224-X	22.3	227	1.02	267	1.20	334	1.50	447	2.01		
12	9-1248-X	12.1	247	2.04	290	2.40	363	3.00	500	4.13		
1	1/2	1 1/4	9-1605-X	202	430	0.21	506	0.25	632	0.31	796	0.39
		1 1/2	9-1606-X	160	408	0.26	480	0.30	600	0.38	756	0.47
		1 3/4	9-1607-X	132	394	0.30	463	0.35	579	0.44	729	0.55
		2	9-1608-X	113	384	0.34	452	0.40	564	0.50	711	0.63
		2 1/2	9-1610-X	87.8	373	0.43	439	0.50	549	0.63	726	0.83
		3	9-1612-X	71.3	364	0.51	428	0.60	535	0.75	702	0.98
		3 1/2	9-1614-X	60.2	358	0.60	421	0.70	527	0.88	687	1.14
		4	9-1616-X	52.1	354	0.68	416	0.80	521	1.00	697	1.34
		4 1/2	9-1618-X	46.3	354	0.77	417	0.90	521	1.13	711	1.54
		5	9-1620-X	41.2	350	0.85	412	1.00	514	1.25	697	1.69
		5 1/2	9-1622-X	37.4	350	0.94	411	1.10	514	1.38	706	1.89
		6	9-1624-X	34.3	350	1.02	412	1.20	515	1.50	716	2.09
7	9-1628-X	29.3	348	1.19	410	1.40	512	1.75	715	2.44		
8	9-1632-X	25.5	347	1.36	408	1.60	510	2.00	703	2.76		
12	9-1648-X	16.9	345	2.04	405	2.40	507	3.00	718	4.25		

Hole Dia. in.	Rod Dia. in.	Free Length in.	CATALOG NUMBER	RATE Pounds Required to Deflect 1/10 in.	LOAD - DEFLECTION TABLE							
					Total Deflection Recommended for Long Life (17% of C)		Total Deflection Recommended for Average Life (20% of C)		Maximum Operating Deflection (25% of C)		Total Travel to Solid	
					Load lbs.	Deflection inches	Load lbs.	Deflection inches	Load lbs.	Deflection inches	Load lbs.	Deflection inches
1 1/4	5/8	1 1/2	9-2006-X	279	712	0.26	837	0.30	1046	0.38	1208	0.43
		1 3/4	9-2007-X	231	687	0.30	809	0.35	1011	0.44	1183	0.51
		2	9-2008-X	197	670	0.34	789	0.40	986	0.50	1165	0.59
		2 1/2	9-2010-X	152	648	0.43	762	0.50	953	0.63	1200	0.79
		3	9-2012-X	123	629	0.51	740	0.60	925	0.75	1165	0.94
		3 1/2	9-2014-X	104	619	0.60	729	0.70	911	0.88	1189	1.14
		4	9-2016-X	89.1	606	0.68	713	0.80	891	1.00	1158	1.30
		4 1/2	9-2018-X	77.8	596	0.77	701	0.90	876	1.13	1103	1.42
		5	9-2020-X	69.7	593	0.85	697	1.00	872	1.25	1126	1.61
		5 1/2	9-2022-X	63.8	596	0.94	701	1.10	877	1.38	1180	1.85
		6	9-2024-X	57.9	590	1.02	694	1.20	868	1.50	1139	1.97
		7	9-2028-X	49.0	583	1.19	686	1.40	857	1.75	1137	2.32
8	9-2032-X	42.8	582	1.36	685	1.60	856	2.00	1146	2.68		
10	9-2040-X	34.1	580	1.70	683	2.00	853	2.50	1142	3.35		
12	9-2048-X	28.3	577	2.04	679	2.40	849	3.00	1148	4.06		
1 1/2	3/4	2	9-2408-X	319	1086	0.34	1278	0.40	1597	0.50	1886	0.59
		2 1/2	9-2410-X	241	1023	0.43	1203	0.50	1504	0.63	1800	0.75
		3	9-2412-X	193	985	0.51	1158	0.60	1448	0.75	1824	0.94
		3 1/2	9-2414-X	161	959	0.60	1128	0.70	1410	0.88	1776	1.10
		4	9-2416-X	139	949	0.68	1116	0.80	1395	1.00	1812	1.30
		4 1/2	9-2418-X	122	933	0.77	1097	0.90	1372	1.13	1776	1.46
		5	9-2420-X	108	922	0.85	1085	1.00	1356	1.25	1751	1.61
		5 1/2	9-2422-X	97.6	913	0.94	1074	1.10	1342	1.38	1767	1.81
		6	9-2424-X	88.8	905	1.02	1065	1.20	1331	1.50	1747	1.97
		7	9-2428-X	75.1	893	1.19	1051	1.40	1314	1.75	1714	2.28
		8	9-2432-X	65.0	884	1.36	1040	1.60	1300	2.00	1715	2.64
		10	9-2440-X	51.7	879	1.70	1034	2.00	1293	2.50	1730	3.35
12	9-2448-X	42.9	876	2.04	1030	2.40	1288	3.00	1724	4.02		
2	1	2 1/2	9-3210-X	413	1756	0.43	2066	0.50	2582	0.63	3091	0.75
		3	9-3212-X	327	1667	0.51	1962	0.60	2452	0.75	2960	0.91
		3 1/2	9-3214-X	271	1610	0.60	1894	0.70	2368	0.88	2876	1.06
		4	9-3216-X	231	1569	0.68	1846	0.80	2308	1.00	2817	1.22
		4 1/2	9-3218-X	201	1539	0.77	1811	0.90	2264	1.13	2773	1.38
		5	9-3220-X	178	1516	0.85	1784	1.00	2229	1.25	2739	1.54
		5 1/2	9-3222-X	160	1500	0.94	1765	1.10	2206	1.38	2779	1.73
		6	9-3224-X	136	1391	1.02	1637	1.20	2046	1.50	2524	1.85
		7	9-3228-X	123	1459	1.19	1716	1.40	2145	1.75	2703	2.20
		8	9-3232-X	106	1442	1.36	1697	1.60	2121	2.00	2672	2.52
		10	9-3240-X	83.5	1419	1.70	1669	2.00	2087	2.50	2629	3.15
		12	9-3248-X	68.9	1405	2.04	1653	2.40	2066	3.00	2630	3.82

INCH



## Spring Retainers

- all steel construction, zinc-plated finish
- compatible with 3/4" and 1", 20 and 25 mm diameter spring rods
- use with any length that allows clearance

READY® Spring Retainers locate and provide a light pre-load to each spring. This allows for easy assembly and disassembly of strippers in a die even while in the press. Broken springs can easily be replaced without long downtime.

Shoulder bolts or spools must be used in conjunction with the READY Spring Retainer.

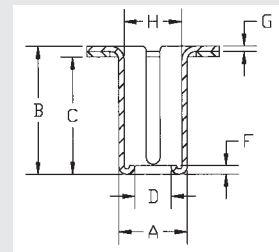
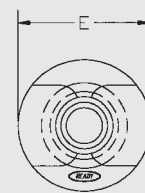
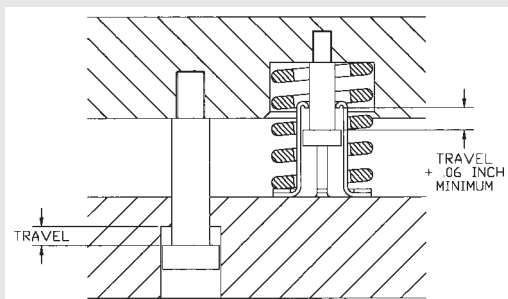

CATALOG NUMBER <i>inch</i>	A	B	C	D	E	F	G	H
9-0615-16	0.79	1.90	1.77	0.39	1.46	0.16	0.05	0.62
9-0815-16	0.99	1.90	1.73	0.53	1.93	0.12	0.08	0.85
9-0823-16	0.99	2.88	2.76	0.53	1.93	0.12	0.08	0.85

CATALOG NUMBER <i>metric</i>	A	B	C	D	E	F	G	H
9-0615-16	20	48	45	10	37	4	1.3	15.8
9-0815-16	25	48	44	13.5	49	3	2	21.5
9-0823-16	25	73	70	13.5	49	3	2	21.5

SPRING RETAINERS



# SuperSprings®

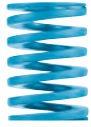

## LIGHT LOAD

Vacuum degassed,  
valve spring quality alloy steel

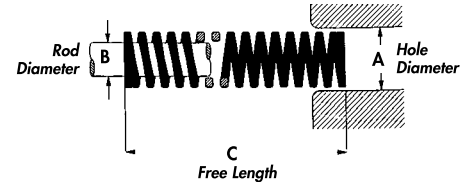

Sizes: 10 to 25 mm, Rectangular Wire Construction

Color: Green

Hole Dia. mm	Rod Dia. mm	Free Length mm	CATALOG NUMBER	RATE Dekanewtons (daN) Required to Deflect 1 mm	LOAD - DEFLECTION TABLE							
					Total Deflection Recommended for Long Life (25% of C)		Total Deflection Recommended for Average Life (30% of C)		Maximum Operating Deflection (40% of C)		Total Travel to Solid	
					Load daN	Deflection mm	Load daN	Deflection mm	Load daN	Deflection mm	Load daN	Deflection mm
<b>Rectangular Wire Construction</b>												
10	5	25	9-0604-LE	1.00	6.3	6.3	7.5	7.5	10.0	10	15.0	15
		32	9-0605-LE	0.85	6.8	8.0	8.2	9.6	10.9	13	16.2	19
		38	9-0606-LE	0.68	6.5	9.5	7.8	11	10.3	15	15.6	23
		44	9-0607-LE	0.60	6.6	11	7.9	13	10.6	18	16.2	27
		51	9-0608-LE	0.50	6.4	13	7.7	15	10.2	20	15.5	31
		64	9-0610-LE	0.43	6.9	16	8.3	19	11.0	26	17.6	41
		76	9-0612-LE	0.32	6.1	19	7.3	23	9.7	30	15.4	48
		305	9-0648-LE	0.11	8.4	76	10.1	92	13.4	122	20.6	187
12.5	6.3	25	9-0804-LE	1.79	11.2	6.3	13.4	7.5	17.9	10	23.3	13
		32	9-0805-LE	1.64	13.1	8.0	15.7	9.6	21.0	13	27.9	17
		38	9-0806-LE	1.36	12.9	9.5	15.5	11	20.7	15	29.9	22
		44	9-0807-LE	1.21	13.3	11	16.0	13	21.3	18	30.3	25
		51	9-0808-LE	1.14	14.5	13	17.4	15	23.3	20	33.1	29
		64	9-0810-LE	0.93	14.9	16	17.9	19	23.8	26	34.4	37
		76	9-0812-LE	0.71	13.5	19	16.2	23	21.6	30	33.4	47
		89	9-0814-LE	0.54	12.0	22	14.4	27	19.2	36	29.2	54
		114	9-0818-LE	0.44	12.5	29	15.0	34	20.1	46	31.7	72
		140	9-0822-LE	0.37	13.0	35	15.5	42	20.7	56	33.7	91
		165	9-0826-LE	0.26	10.7	41	12.9	50	17.2	66	25.7	99
190	9-0830-LE	0.20	9.5	48	11.4	57	15.2	76	22.2	111		
305	9-0848-LE	0.14	10.7	76	12.8	92	17.1	122	25.8	184		
16	8	25	9-1004-LE	2.34	14.6	6.3	17.6	7.5	23.4	10	25.7	11
		32	9-1005-LE	2.29	18.3	8.0	22.0	9.6	29.3	13	38.9	17
		38	9-1006-LE	1.93	18.3	9.5	22.0	11	29.3	15	38.6	20
		44	9-1007-LE	1.71	18.8	11	22.6	13	30.1	18	41.0	24
		51	9-1008-LE	1.57	20.0	13	24.0	15	32.0	20	45.5	29
		64	9-1010-LE	1.07	17.1	16	20.5	19	27.4	26	39.6	37
		76	9-1012-LE	1.00	19.0	19	22.8	23	30.4	30	42.0	42
		89	9-1014-LE	0.86	19.1	22	23.0	27	30.6	36	43.9	51
		102	9-1016-LE	0.78	19.9	26	23.9	31	31.8	41	48.4	62
		305	9-1048-LE	0.25	19.1	76	22.9	92	30.5	122	45.3	181
20	10	25	9-1204-L	5.56	34.8	6.3	41.7	7.5	55.6	10	72.3	13
		32	9-1205-L	4.27	34.2	8.0	41.0	9.6	54.7	13	68.4	16
		38	9-1206-L	3.39	32.2	9.5	38.6	11	51.5	15	64.4	19
		44	9-1207-L	2.85	31.4	11	37.6	13	50.2	18	65.6	23
		51	9-1208-L	2.47	31.5	13	37.8	15	50.4	20	64.2	26
		64	9-1210-L	1.93	30.8	16	37.0	19	49.3	26	61.6	32
		76	9-1212-L	1.61	30.6	19	36.7	23	48.9	30	64.4	40
		89	9-1214-L	1.35	29.9	22	35.9	27	47.9	36	61.9	46
		102	9-1216-L	1.18	30.1	26	36.2	31	48.2	41	62.7	53
		115	9-1218-L	1.04	29.9	29	35.8	35	47.8	46	62.3	60
		127	9-1220-L	0.94	29.8	32	35.8	38	47.8	51	63.0	67
		140	9-1222-L	0.85	29.7	35	35.7	42	47.6	56	62.0	73
		152	9-1224-L	0.79	29.9	38	35.9	46	47.9	61	63.8	81
		305	9-1248-L	0.38	28.8	76	34.6	92	46.2	122	61.3	162
25	12.5	25	9-1604-L	10.00	62.5	6.3	75.0	7.5	100	10	130	13
		32	9-1605-L	8.06	64.4	8.0	77.3	9.6	103	13	129	16
		38	9-1606-L	6.48	61.6	9.5	73.9	11	98.5	15	123	19
		44	9-1607-L	5.33	58.6	11	70.4	13	93.8	18	123	23
		51	9-1608-L	4.62	58.9	13	70.7	15	94.2	20	116	25
		64	9-1610-L	3.57	57.2	16	68.6	19	91.5	26	111	31
		76	9-1612-L	2.92	55.6	19	66.7	23	88.9	30	114	39
		89	9-1614-L	2.48	55.2	22	66.2	27	88.3	36	114	46
		102	9-1616-L	2.12	54.0	26	64.8	31	86.5	41	110	52
		115	9-1618-L	1.87	53.9	29	64.6	35	86.2	46	111	59
		127	9-1620-L	1.67	53.2	32	63.8	38	85.1	51	111	66
		140	9-1622-L	1.52	53.2	35	63.8	42	85.1	56	112	74
		152	9-1624-L	1.39	52.8	38	63.4	46	84.5	61	111	80
		178	9-1628-L	1.19	53.0	45	63.5	53	84.7	71	111	93
		203	9-1632-L	1.05	53.4	51	64.1	61	85.5	81	113	107
		305	9-1648-L	0.70	53.3	76	63.9	92	85.3	122	112	160

1 daN = 2.24 lbs. 1 mm = .0394 in.

Sizes: 32 to 63 mm, Rectangular Wire Construction

Sizes: 10 to 16 mm, Round Wire Construction

Color: Green

Hole Dia. mm	Rod Dia. mm	Free Length mm	CATALOG NUMBER	RATE Dekanewtons (daN) Required to Deflect 1 mm	LOAD - DEFLECTION TABLE									
					Total Deflection Recommended for Long Life (25% of C)		Total Deflection Recommended for Average Life (30% of C)		Maximum Operating Deflection (40% of C)		Total Travel to Solid			
					Load daN	Deflection mm	Load daN	Deflection mm	Load daN	Deflection mm	Load daN	Deflection mm		
32	16	38	9 - 2006 - L	9.40	89.3	9.5	107	11	143	15	179	19		
		44	9 - 2007 - L	7.95	87.5	11	105	13	140	18	175	22		
		51	9 - 2008 - L	6.70	85.4	13	103	15	137	20	168	25		
		64	9 - 2010 - L	5.50	88.0	16	106	19	141	26	176	32		
		76	9 - 2012 - L	4.60	87.4	19	105	23	140	30	179	39		
		89	9 - 2014 - L	3.72	82.8	22	99.3	27	132	36	167	45		
		102	9 - 2016 - L	3.20	81.6	26	97.9	31	131	41	166	52		
		115	9 - 2018 - L	2.96	85.1	29	102	35	136	46	172	58		
		127	9 - 2020 - L	2.50	79.4	32	95.3	38	127	51	163	65		
		140	9 - 2022 - L	2.35	82.3	35	98.7	42	132	56	169	72		
		152	9 - 2024 - L	2.15	81.9	38	98.2	46	131	61	168	78		
		178	9 - 2028 - L	1.82	81.1	45	97.3	53	130	71	160	88		
		203	9 - 2032 - L	1.59	80.5	51	96.6	61	129	81	165	104		
		254	9 - 2040 - L	1.26	80.0	64	96.0	76	128	102	164	130		
305	9 - 2048 - L	1.04	79.1	76	94.9	92	126	122	161	155				
40	20	51	9 - 2408 - L	9.20	117	13	141	15	188	20	230	25		
		64	9 - 2410 - L	7.29	117	16	140	19	187	26	233	32		
		76	9 - 2412 - L	6.30	120	19	144	23	192	30	239	38		
		89	9 - 2414 - L	5.10	113	22	136	27	182	36	230	45		
		102	9 - 2416 - L	4.30	110	26	132	31	175	41	219	51		
		115	9 - 2418 - L	3.96	114	29	137	35	182	46	230	58		
		127	9 - 2420 - L	3.70	117	32	141	38	188	51	241	65		
		140	9 - 2422 - L	3.20	112	35	134	42	179	56	227	71		
		152	9 - 2424 - L	2.80	106	38	128	46	170	61	218	78		
		178	9 - 2428 - L	2.52	112	45	135	53	179	71	232	92		
		203	9 - 2432 - L	2.27	115	51	138	61	184	81	238	105		
		254	9 - 2440 - L	1.70	108	64	130	76	173	102	223	131		
		305	9 - 2448 - L	1.48	113	76	136	92	181	122	233	157		
		50	25	64	9 - 3210 - L	15.7	251	16	302	19	402	26	503	32
76	9 - 3212 - L			12.6	240	19	287	23	383	30	492	39		
89	9 - 3214 - L			10.5	234	22	281	27	375	36	473	45		
102	9 - 3216 - L			8.98	229	26	275	31	366	41	467	52		
115	9 - 3218 - L			7.67	221	29	265	35	353	46	445	58		
127	9 - 3220 - L			7.01	222	32	267	38	356	51	455	65		
140	9 - 3222 - L			6.30	221	35	265	42	353	56	454	72		
152	9 - 3224 - L			5.74	218	38	262	46	349	61	448	78		
178	9 - 3228 - L			4.87	217	45	260	53	347	71	448	92		
203	9 - 3232 - L			4.15	211	51	253	61	337	81	432	104		
254	9 - 3240 - L			3.29	209	64	251	76	335	102	428	130		
305	9 - 3248 - L			2.71	207	76	248	92	331	122	423	156		
63	38			76	9 - 4012 - L	19.3	366	19	439	23	586	30	732	38
				89	9 - 4014 - L	15.8	351	22	422	27	562	36	695	44
		102	9 - 4016 - L	13.4	341	26	409	31	546	41	669	50		
		115	9 - 4018 - L	11.6	333	29	400	35	533	46	661	57		
		127	9 - 4020 - L	10.2	323	32	387	38	516	51	650	64		
		152	9 - 4024 - L	8.36	318	38	381	46	508	61	635	76		
		178	9 - 4028 - L	7.02	313	45	375	53	500	71	625	89		
		203	9 - 4032 - L	6.04	307	51	368	61	491	81	616	102		
		254	9 - 4040 - L	4.69	298	64	358	76	477	102	591	126		
		305	9 - 4048 - L	3.87	295	76	354	92	472	122	588	152		

**Round Wire Construction**

10	5	25	9 - 0604 - L	0.46	2.9	6.3	3.5	7.5	4.6	10	6.0	13
		32	9 - 0605 - L	0.35	2.8	8.0	3.4	9.6	4.5	13	5.6	16
		38	9 - 0606 - L	0.28	2.7	9.5	3.2	11	4.3	15	5.7	20
		44	9 - 0607 - L	0.24	2.6	11	3.1	13	4.2	18	5.5	23
		51	9 - 0608 - L	0.21	2.7	13	3.2	15	4.3	20	5.7	27
		64	9 - 0610 - L	0.17	2.7	16	3.3	19	4.4	26	5.8	34
		76	9 - 0612 - L	0.13	2.5	19	3.0	23	4.0	30	5.3	40
		305	9 - 0648 - L	0.03	2.4	76	2.9	92	3.8	122	5.1	163
12.5	6.3	25	9 - 0804 - L	0.90	5.6	6.3	6.8	7.5	9.0	10	11.7	13
		32	9 - 0805 - L	0.67	5.4	8.0	6.5	9.6	8.6	13	11.4	17
		38	9 - 0806 - L	0.54	5.1	9.5	6.2	11	8.2	15	10.8	20
		44	9 - 0807 - L	0.46	5.0	11	6.0	13	8.0	18	10.5	23
		51	9 - 0808 - L	0.39	4.9	13	5.9	15	7.9	20	10.5	27
		64	9 - 0810 - L	0.30	4.8	16	5.7	19	7.7	26	10.5	35
		76	9 - 0812 - L	0.25	4.8	19	5.8	23	7.7	30	10.4	41
		305	9 - 0848 - L	0.06	4.5	76	5.4	92	7.3	122	9.9	166
16	8	25	9 - 1004 - L	1.78	11.1	6.3	13.4	7.5	17.8	10	23.1	13
		32	9 - 1005 - L	1.34	10.7	8.0	12.9	9.6	17.2	13	21.4	16
		38	9 - 1006 - L	1.06	10.0	9.5	12.0	11	16.1	15	21.1	20
		44	9 - 1007 - L	0.87	9.6	11	11.5	13	15.3	18	20.0	23
		51	9 - 1008 - L	0.76	9.7	13	11.6	15	15.5	20	20.5	27
		64	9 - 1010 - L	0.59	9.5	16	11.4	19	15.2	26	20.1	34
		76	9 - 1012 - L	0.48	9.1	19	10.9	23	14.5	30	19.6	41
		89	9 - 1014 - L	0.41	9.1	22	10.9	27	14.6	36	20.1	49
		102	9 - 1016 - L	0.35	9.0	26	10.8	31	14.4	41	19.7	56
		305	9 - 1048 - L	0.11	8.5	76	10.3	92	13.7	122	19.1	170

METRIC

1 daN = 2.24 lbs. 1 mm = .0394 in.

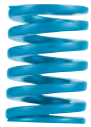

**MEDIUM LOAD**

Vacuum degassed, valve spring quality alloy steel

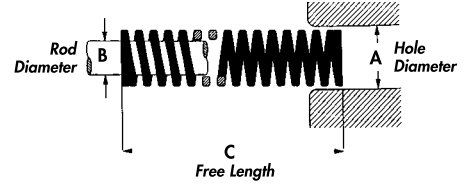

Sizes: 10 to 25 mm, Rectangular Wire Construction

Color: Blue

Hole Dia. mm	Rod Dia. mm	Free Length mm	CATALOG NUMBER	RATE Dekanewtons (daN) Required to Deflect 1 mm	LOAD - DEFLECTION TABLE							
					Total Deflection Recommended for Long Life (25% of C)		Total Deflection Recommended for Average Life (30% of C)		Maximum Operating Deflection (37.5% of C)		Total Travel to Solid	
					Load daN	Deflection mm	Load daN	Deflection mm	Load daN	Deflection mm	Load daN	Deflection mm
<b>Rectangular Wire Construction</b>												
10	5	25	9 - 0604 - ME	1.60	10.0	6.3	12.0	7.5	15.0	9.4	17.6	11
		32	9 - 0605 - ME	1.30	10.4	8.0	12.5	9.6	15.6	12	23.4	18
		38	9 - 0606 - ME	1.19	11.3	9.5	13.6	11	17.0	14	23.8	20
		44	9 - 0607 - ME	1.03	11.3	11	13.6	13	17.0	17	22.7	22
		51	9 - 0608 - ME	0.89	11.3	13	13.6	15	17.0	19	23.1	26
		64	9 - 0610 - ME	0.75	12.0	16	14.4	19	18.0	24	24.0	32
		76	9 - 0612 - ME	0.53	10.1	19	12.1	23	15.1	29	20.1	38
		305	9 - 0648 - ME	0.16	12.2	76	14.6	92	18.3	114	23.8	149
12.5	6.3	25	9 - 0804 - ME	3.00	18.8	6.3	22.5	7.5	28.1	9.4	39.0	13
		32	9 - 0805 - ME	2.48	19.8	8.0	23.8	9.6	29.8	12	44.6	18
		38	9 - 0806 - ME	2.14	20.3	9.5	24.4	11	30.5	14	42.8	20
		44	9 - 0807 - ME	1.85	20.4	11	24.4	13	30.5	17	44.4	24
		51	9 - 0808 - ME	1.55	19.8	13	23.7	15	29.6	19	43.4	28
		64	9 - 0810 - ME	1.21	19.4	16	23.2	19	29.0	24	42.4	35
		76	9 - 0812 - ME	1.02	19.4	19	23.3	23	29.1	29	41.8	41
		89	9 - 0814 - ME	0.84	18.7	22	22.4	27	28.0	33	41.2	49
305	9 - 0848 - ME	0.21	16.0	76	19.2	92	24.0	114	31.3	149		
16	8	25	9 - 1004 - ME	4.94	30.9	6.3	37.1	7.5	46.3	9.4	59.3	12
		32	9 - 1005 - ME	3.71	29.7	8.0	35.6	9.6	44.5	12	55.7	15
		38	9 - 1006 - ME	3.39	32.2	9.5	38.6	11	48.3	14	64.4	19
		44	9 - 1007 - ME	3.00	33.0	11	39.6	13	49.5	17	63.0	21
		51	9 - 1008 - ME	2.64	33.7	13	40.4	15	50.5	19	66.0	25
		64	9 - 1010 - ME	2.05	32.8	16	39.4	19	49.2	24	65.6	32
		76	9 - 1012 - ME	1.78	33.8	19	40.6	23	50.7	29	69.4	39
		89	9 - 1014 - ME	1.52	33.8	22	40.6	27	50.7	33	68.4	45
102	9 - 1016 - ME	1.35	34.4	26	41.3	31	51.6	38	71.6	53		
305	9 - 1048 - ME	0.48	36.6	76	43.9	92	54.9	114	72.0	150		
20	10	25	9 - 1204 - M	9.03	56.4	6.3	67.7	7.5	84.7	9.4	99.3	11
		32	9 - 1205 - M	6.83	54.6	8.0	65.6	9.6	82.0	12	88.8	13
		38	9 - 1206 - M	5.51	52.3	9.5	62.8	11	78.5	14	88.2	16
		44	9 - 1207 - M	4.50	49.5	11	59.4	13	74.3	17	85.5	19
		51	9 - 1208 - M	3.89	49.6	13	59.5	15	74.4	19	81.7	21
		64	9 - 1210 - M	3.04	48.6	16	58.4	19	73.0	24	82.1	27
		76	9 - 1212 - M	2.48	47.1	19	56.5	23	70.7	29	81.8	33
		89	9 - 1214 - M	2.13	47.3	22	56.9	27	71.1	33	83.1	39
		102	9 - 1216 - M	1.86	47.4	26	56.8	31	71.0	38	81.7	44
		115	9 - 1218 - M	1.63	46.9	29	56.3	35	70.4	43	80.0	49
		127	9 - 1220 - M	1.47	46.7	32	56.0	38	70.0	48	80.9	55
		140	9 - 1222 - M	1.33	46.6	35	55.9	42	69.8	53	81.1	61
		152	9 - 1224 - M	1.20	45.6	38	54.7	46	68.4	57	79.2	66
		305	9 - 1248 - M	0.61	46.2	76	55.4	92	69.3	114	82.4	136
25	12.5	25	9 - 1604 - M	15.1	94.2	6.3	113	7.5	141	9.4	166	11
		32	9 - 1605 - M	11.9	94.8	8.0	114	9.6	142	12	154	13
		38	9 - 1606 - M	9.34	88.7	9.5	106	11	133	14	149	16
		44	9 - 1607 - M	8.32	91.5	11	110	13	137	17	158	19
		51	9 - 1608 - M	6.89	87.8	13	105	15	132	19	145	21
		64	9 - 1610 - M	5.32	85.1	16	102	19	128	24	144	27
		76	9 - 1612 - M	4.33	82.3	19	98.7	23	123	29	143	33
		89	9 - 1614 - M	3.80	84.6	22	101	27	127	33	148	39
		102	9 - 1616 - M	3.30	84.2	26	101	31	126	38	145	44
		115	9 - 1618 - M	2.93	84.2	29	101	35	126	43	147	50
		127	9 - 1620 - M	2.64	83.8	32	101	38	126	48	148	56
		140	9 - 1622 - M	2.38	83.3	35	100	42	125	53	150	63
		152	9 - 1624 - M	2.18	82.8	38	99.4	46	124	57	146	67
		178	9 - 1628 - M	1.85	82.3	45	98.8	53	123	67	146	79
203	9 - 1632 - M	1.60	81.0	51	97.2	61	121	76	144	90		
305	9 - 1648 - M	1.05	79.7	76	95.7	92	120	114	141	135		

1 daN = 2.24 lbs. 1 mm = .0394 in.

Sizes: 32 to 63 mm, Rectangular Wire Construction

Sizes: 10 to 16 mm, Round Wire Construction

Color: Blue

Hole Dia. mm	Rod Dia. mm	Free Length mm	CATALOG NUMBER	RATE Deka-newtons (daN) Required to Deflect 1 mm	LOAD - DEFLECTION TABLE									
					Total Deflection Recommended for Long Life (25% of C)		Total Deflection Recommended for Average Life (30% of C)		Maximum Operating Deflection (37.5% of C)		Total Travel to Solid			
					Load daN	Deflection mm	Load daN	Deflection mm	Load daN	Deflection mm	Load daN	Deflection mm		
A	B	C												
32	16	38	9-2006-M	16.6	158	9.5	189	11	237	14	266	16		
		44	9-2007-M	13.6	150	11	180	13	225	17	259	19		
		51	9-2008-M	11.6	148	13	177	15	222	19	244	21		
		64	9-2010-M	8.76	140	16	168	19	210	24	237	27		
		76	9-2012-M	7.10	135	19	162	23	202	29	227	32		
		89	9-2014-M	5.99	133	22	160	27	200	33	222	37		
		102	9-2016-M	5.19	132	26	159	31	199	38	223	43		
		115	9-2018-M	4.61	132	29	159	35	199	43	226	49		
		127	9-2020-M	4.15	132	32	158	38	198	48	228	55		
		140	9-2022-M	3.75	131	35	157	42	197	53	225	60		
		152	9-2024-M	3.39	129	38	155	46	193	57	224	66		
		178	9-2028-M	2.91	129	45	155	53	194	67	224	77		
		203	9-2032-M	2.52	128	51	154	61	192	76	222	88		
		254	9-2040-M	1.99	126	64	152	76	190	95	219	110		
305	9-2048-M	1.66	127	76	152	92	190	114	221	133				
40	20	51	9-2408-M	17.1	218	13	261	15	326	19	358	21		
		64	9-2410-M	12.9	206	16	247	19	309	24	335	26		
		76	9-2412-M	10.5	200	19	240	23	300	29	337	32		
		89	9-2414-M	8.79	196	22	235	27	293	33	325	37		
		102	9-2416-M	7.61	194	26	233	31	291	38	327	43		
		115	9-2418-M	6.65	191	29	230	35	287	43	319	48		
		127	9-2420-M	5.94	189	32	226	38	283	48	321	54		
		140	9-2422-M	5.36	188	35	225	42	281	53	316	59		
		152	9-2424-M	4.91	187	38	224	46	280	57	319	65		
		178	9-2428-M	4.15	185	45	222	53	277	67	315	76		
		203	9-2432-M	3.62	184	51	220	61	276	76	315	87		
		254	9-2440-M	2.90	184	64	221	76	276	95	319	110		
		305	9-2448-M	2.37	181	76	217	92	271	114	310	131		
		50	25	64	9-3210-M	21.2	339	16	406	19	508	24	572	27
76	9-3212-M			16.8	318	19	382	23	477	29	536	32		
89	9-3214-M			14.0	312	22	375	27	469	33	519	37		
102	9-3216-M			12.2	310	26	372	31	465	38	523	43		
115	9-3218-M			10.7	308	29	369	35	462	43	525	49		
127	9-3220-M			9.46	300	32	360	38	450	48	511	54		
140	9-3222-M			8.54	299	35	359	42	448	53	504	59		
152	9-3224-M			7.81	297	38	356	46	445	57	516	66		
178	9-3228-M			6.64	295	45	354	53	443	67	511	77		
203	9-3232-M			5.75	292	51	350	61	438	76	506	88		
229	9-3236-M			5.08	291	57	349	69	436	86	508	100		
254	9-3240-M			4.58	291	64	349	76	436	95	536	117		
305	9-3248-M			3.88	296	76	355	92	444	114	520	134		
63	38			76	9-4012-M	30.4	578	19	693	23	867	29	973	32
		89	9-4014-M	25.0	556	22	667	27	833	33	949	38		
		102	9-4016-M	21.2	540	26	648	31	810	38	931	44		
		115	9-4018-M	18.6	535	29	642	35	802	43	930	50		
		127	9-4020-M	16.4	521	32	626	38	782	48	920	56		
		152	9-4024-M	13.3	504	38	605	46	756	57	889	67		
		178	9-4028-M	11.2	497	45	596	53	745	67	870	78		
		203	9-4032-M	9.62	488	51	586	61	732	76	866	90		
		229	9-4036-M	8.53	488	57	586	69	733	86	870	102		
		254	9-4040-M	7.67	487	64	584	76	731	95	882	115		
		305	9-4048-M	6.34	483	76	580	92	725	114	875	138		
		<b>Round Wire Construction</b>												
		10	5	25	9-0604-M	1.25	7.8	6.3	9.4	7.5	11.7	9.4	13.8	11
				32	9-0605-M	0.97	7.8	8.0	9.3	9.6	11.6	12	12.6	13
38	9-0606-M			0.78	7.4	9.5	8.9	11	11.1	14	12.5	16		
44	9-0607-M			0.66	7.3	11	8.8	13	11.0	17	12.6	19		
51	9-0608-M			0.57	7.3	13	8.8	15	11.0	19	12.0	21		
64	9-0610-M			0.45	7.2	16	8.7	19	10.8	24	12.2	27		
76	9-0612-M			0.37	7.0	19	8.4	23	10.5	29	12.2	33		
305	9-0648-M	0.09	6.8	76	8.2	92	10.2	114	12.1	136				
12.5	6.3	25	9-0804-M	2.28	14.2	6.3	17.1	7.5	21.3	9.4	25.0	11		
		32	9-0805-M	1.75	14.0	8.0	16.8	9.6	21.0	12	22.7	13		
		38	9-0806-M	1.42	13.5	9.5	16.2	11	20.2	14	22.7	16		
		44	9-0807-M	1.17	12.9	11	15.4	13	19.3	17	22.2	19		
		51	9-0808-M	1.01	12.9	13	15.5	15	19.3	19	22.2	22		
		64	9-0810-M	0.79	12.7	16	15.2	19	19.0	24	22.2	28		
		76	9-0812-M	0.65	12.3	19	14.8	23	18.5	29	22.1	34		
		89	9-0814-M	0.57	12.7	22	15.2	27	19.0	33	23.3	41		
305	9-0848-M	0.16	12.2	76	14.6	92	18.3	114	23.0	144				
16	8	25	9-1004-M	3.38	21.1	6.3	25.4	7.5	31.7	9.4	37.2	11		
		32	9-1005-M	2.51	20.1	8.0	24.1	9.6	30.1	12	32.6	13		
		38	9-1006-M	2.01	19.1	9.5	23.0	11	28.7	14	32.2	16		
		44	9-1007-M	1.67	18.4	11	22.0	13	27.6	17	31.7	19		
		51	9-1008-M	1.42	18.1	13	21.7	15	27.1	19	29.8	21		
		64	9-1010-M	1.10	17.5	16	21.0	19	26.3	24	29.6	27		
		76	9-1012-M	0.89	17.0	19	20.4	23	25.5	29	29.5	33		
		89	9-1014-M	0.76	16.9	22	20.3	27	25.4	33	29.6	39		
		102	9-1016-M	0.67	17.1	26	20.5	31	25.6	38	30.2	45		
		305	9-1048-M	0.21	16.0	76	19.2	92	24.0	114	29.0	138		

METRIC

1 daN = 2.24 lbs. 1 mm = .0394 in.



# HEAVY LOAD

Vacuum degassed,  
valve spring quality alloy steel

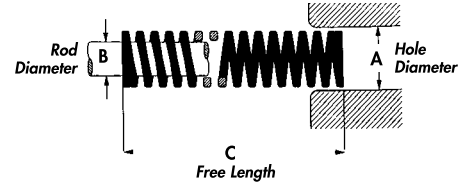

Sizes: 10 to 25 mm, Rectangular Wire Construction

Color: Red

Hole Dia. mm	Rod Dia. mm	Free Length mm	CATALOG NUMBER	RATE Dekanewtons (daN) Required to Deflect 1 mm	LOAD - DEFLECTION TABLE								
					Total Deflection Recommended for Long Life (20% of C)		Total Deflection Recommended for Average Life (25% of C)		Maximum Operating Deflection (30% of C)		Total Travel to Solid		
					Load daN	Deflection mm	Load daN	Deflection mm	Load daN	Deflection mm	Load daN	Deflection mm	
A	B	C											
<b>Rectangular Wire Construction</b>													
10	5	25	9 - 0604 - HE	2.21	11.1	5.0	13.8	6.3	16.6	7.5	26.5	12	
		32	9 - 0605 - HE	1.75	11.2	6.4	14.0	8.0	16.8	9.6	22.8	13	
		38	9 - 0606 - HE	1.71	13.0	7.6	16.2	9.5	19.5	11	25.7	15	
		44	9 - 0607 - HE	1.50	13.2	8.8	16.5	11	19.8	13	28.5	19	
		51	9 - 0608 - HE	1.28	13.1	10	16.3	13	19.6	15	29.4	23	
		64	9 - 0610 - HE	1.07	13.7	13	17.1	16	20.5	19	28.9	27	
		76	9 - 0612 - HE	0.75	11.4	15	14.3	19	17.1	23	24.0	32	
		305	9 - 0648 - HE	0.21	12.8	61	16.0	76	19.2	92	29.4	140	
12.5	6.3	25	9 - 0804 - HE	4.21	21.1	5.0	26.3	6.3	31.6	7.5	50.5	12	
		32	9 - 0805 - HE	3.32	21.2	6.4	26.6	8.0	31.9	9.6	53.1	16	
		38	9 - 0806 - HE	2.93	22.3	7.6	27.8	9.5	33.4	11	58.6	20	
		44	9 - 0807 - HE	2.46	21.6	8.8	27.1	11	32.5	13	54.1	22	
		51	9 - 0808 - HE	1.96	20.0	10	25.0	13	30.0	15	49.0	25	
		64	9 - 0810 - HE	1.50	19.2	13	24.0	16	28.8	19	45.0	30	
		76	9 - 0812 - HE	1.32	20.1	15	25.1	19	30.1	23	48.8	37	
		305	9 - 0848 - HE	0.28	17.1	61	21.4	76	25.6	92	36.4	130	
16	8	25	9 - 1004 - HE	7.57	37.9	5.0	47.3	6.3	56.8	7.5	76	10	
		32	9 - 1005 - HE	5.28	33.8	6.4	42.2	8.0	50.7	9.6	69	13	
		38	9 - 1006 - HE	4.85	36.9	7.6	46.1	9.5	55.3	11	82	17	
		44	9 - 1007 - HE	4.28	37.7	8.8	47.1	11	56.5	13	90	21	
		51	9 - 1008 - HE	3.71	37.8	10	47.3	13	56.8	15	85	23	
		64	9 - 1010 - HE	3.03	38.8	13	48.5	16	58.2	19	88	29	
		76	9 - 1012 - HE	2.57	39.1	15	48.8	19	58.6	23	87	34	
		89	9 - 1014 - HE	2.17	38.6	18	48.3	22	57.9	27	85	39	
		102	9 - 1016 - HE	1.93	39.4	20	49.2	26	59.1	31	87	45	
		305	9 - 1048 - HE	0.71	43.3	61	54.1	76	65.0	92	82	116	
20	10	25	9 - 1204 - H	21.6	108	5.0	135	6.3	162	7.5	173	8	
		32	9 - 1205 - H	16.8	108	6.4	134	8.0	161	9.6	168	10	
		38	9 - 1206 - H	12.9	98.0	7.6	123	9.5	147	11	155	12	
		44	9 - 1207 - H	11.2	98.6	8.8	123	11	148	13	157	14	
		51	9 - 1208 - H	9.40	95.9	10	120	13	144	15	150	16	
		64	9 - 1210 - H	7.21	92.3	13	115	16	138	19	151	21	
		76	9 - 1212 - H	5.97	90.7	15	113	19	136	23	155	26	
		89	9 - 1214 - H	5.05	89.9	18	112	22	135	27	152	30	
		102	9 - 1216 - H	4.42	90.2	20	113	26	135	31	155	35	
		115	9 - 1218 - H	3.84	88.3	23	110	29	132	35	154	40	
		127	9 - 1220 - H	3.41	86.6	25	108	32	130	38	150	44	
		140	9 - 1222 - H	3.10	86.8	28	109	35	130	42	152	49	
		152	9 - 1224 - H	2.82	85.7	30	107	38	129	46	149	53	
		305	9 - 1248 - H	1.50	91.5	61	114	76	137	92	162	108	
25	12.5	25	9 - 1604 - H	38.0	190	5.0	238	6.3	285	7.5	304	8	
		32	9 - 1605 - H	27.6	177	6.4	221	8.0	265	9.6	276	10	
		38	9 - 1606 - H	22.0	167	7.6	209	9.5	250	11	286	13	
		44	9 - 1607 - H	18.5	162	8.8	203	11	244	13	277	15	
		51	9 - 1608 - H	15.7	160	10	201	13	241	15	283	18	
		64	9 - 1610 - H	12.2	156	13	195	16	233	19	268	22	
		76	9 - 1612 - H	10.0	152	15	190	19	228	23	270	27	
		89	9 - 1614 - H	8.44	150	18	188	22	225	27	279	33	
		102	9 - 1616 - H	7.35	150	20	187	26	225	31	272	37	
		115	9 - 1618 - H	6.52	150	23	187	29	225	35	280	43	
		127	9 - 1620 - H	5.75	146	25	183	32	219	38	270	47	
		140	9 - 1622 - H	5.21	146	28	182	35	219	42	271	52	
		152	9 - 1624 - H	4.80	146	30	182	38	219	46	274	57	
		178	9 - 1628 - H	4.09	146	36	182	45	218	53	278	68	
		203	9 - 1632 - H	3.57	145	41	181	51	217	61	275	77	
		305	9 - 1648 - H	2.29	140	61	175	76	210	92	263	115	

1 daN = 2.24 lbs. 1 mm = .0394 in.



Sizes: 32 to 50 mm, Rectangular Wire Construction

Sizes: 10 to 16 mm, Round Wire Construction

Color: Red

Hole Dia. mm	Rod Dia. mm	Free Length mm	CATALOG NUMBER	RATE Dekanewtons (daN) Required to Deflect 1 mm	LOAD - DEFLECTION TABLE							
					Total Deflection Recommended for Long Life (20% of C)		Total Deflection Recommended for Average Life (25% of C)		Maximum Operating Deflection (30% of C)		Total Travel to Solid	
					Load daN	Deflection mm	Load daN	Deflection mm	Load daN	Deflection mm	Load daN	Deflection mm
32	16	38	9-2006-H	37.6	286	7.6	357	9.5	429	11	451	12
		44	9-2007-H	31.0	272	8.8	341	11	409	13	433	14
		51	9-2008-H	26.3	269	10	336	13	403	15	421	16
		64	9-2010-H	20.5	262	13	327	16	393	19	430	21
		76	9-2012-H	16.6	252	15	315	19	378	23	432	26
		89	9-2014-H	14.0	250	18	313	22	375	27	421	30
		102	9-2016-H	12.1	247	20	309	26	370	31	424	35
		115	9-2018-H	10.6	245	23	306	29	367	35	426	40
		127	9-2020-H	9.58	243	25	304	32	365	38	431	45
		140	9-2022-H	8.64	242	28	302	35	363	42	432	50
		152	9-2024-H	7.87	239	30	299	38	359	46	425	54
		178	9-2028-H	6.67	238	36	297	45	356	53	420	63
		203	9-2032-H	5.79	235	41	294	51	352	61	417	72
		254	9-2040-H	4.63	235	51	294	64	353	76	426	92
		305	9-2048-H	3.82	233	61	291	76	349	92	420	110
40	20	51	9-2408-H	35.2	359	10	449	13	539	15	599	17
		64	9-2410-H	26.8	344	13	429	16	515	19	590	22
		76	9-2412-H	21.9	333	15	416	19	500	23	592	27
		89	9-2414-H	18.5	329	18	411	22	493	27	591	32
		102	9-2416-H	15.9	324	20	405	26	486	31	588	37
		115	9-2418-H	14.1	324	23	405	29	486	35	592	42
		127	9-2420-H	12.5	318	25	398	32	477	38	589	47
		140	9-2422-H	11.3	316	28	394	35	473	42	586	52
		152	9-2424-H	10.4	315	30	393	38	472	46	590	57
		178	9-2428-H	8.81	314	36	392	45	470	53	590	67
		203	9-2432-H	7.67	311	41	389	51	467	61	583	76
		254	9-2440-H	6.05	307	51	384	64	461	76	587	97
305	9-2448-H	5.02	306	61	383	76	459	92	582	116		
50	25	64	9-3210-H	42.4	542	13	678	16	814	19	890	21
		76	9-3212-H	33.8	514	15	643	19	771	23	879	26
		89	9-3214-H	28.1	501	18	626	22	751	27	844	30
		102	9-3216-H	24.5	500	20	625	26	750	31	858	35
		115	9-3218-H	21.5	495	23	618	29	742	35	860	40
		127	9-3220-H	18.9	481	25	601	32	721	38	852	45
		140	9-3222-H	16.9	473	28	592	35	710	42	845	50
		152	9-3224-H	15.4	469	30	586	38	704	46	833	54
		178	9-3228-H	13.2	468	36	585	45	702	53	842	64
		203	9-3232-H	11.5	468	41	585	51	702	61	830	72
		254	9-3240-H	9.04	459	51	574	64	689	76	832	92
		305	9-3248-H	7.47	456	61	570	76	684	92	837	112
<b>Round Wire Construction</b>												
10	5	25	9-0604-H	2.14	10.7	5.0	13.4	6.3	16.0	7.5	19.2	9
		32	9-0605-H	1.65	10.5	6.4	13.2	8.0	15.8	9.6	19.8	12
		38	9-0606-H	1.33	10.1	7.6	12.6	9.5	15.2	11	18.6	14
		44	9-0607-H	1.17	10.3	8.8	12.9	11	15.4	13	19.9	17
		51	9-0608-H	0.98	10.0	10	12.5	13	15.0	15	18.6	19
		64	9-0610-H	0.77	9.9	13	12.3	16	14.8	19	19.3	25
		76	9-0612-H	0.63	9.6	15	12.0	19	14.4	23	18.3	29
305	9-0648-H	0.15	9.3	61	11.6	76	13.9	92	18.3	120		
12.5	6.3	25	9-0804-H	3.94	19.7	5.0	24.6	6.3	29.6	7.5	35.3	9
		32	9-0805-H	3.01	19.3	6.4	24.1	8.0	28.9	9.6	33.1	11
		38	9-0806-H	2.42	18.4	7.6	23.0	9.5	27.6	11	31.4	13
		44	9-0807-H	2.01	17.7	8.8	22.2	11	26.6	13	32.2	16
		51	9-0808-H	1.77	18.0	10	22.6	13	27.1	15	33.6	19
		64	9-0810-H	1.38	17.7	13	22.1	16	26.6	19	33.2	24
		76	9-0812-H	1.14	17.3	15	21.6	19	26.0	23	33.0	29
89	9-0814-H	0.96	17.1	18	21.4	22	25.7	27	31.8	33		
305	9-0848-H	0.27	16.3	61	20.4	76	24.5	92	32.2	120		
16	8	25	9-1004-H	8.69	43.5	5.0	54.3	6.3	65.2	7.5	78.2	9
		32	9-1005-H	6.37	40.8	6.4	51.0	8.0	61.2	9.6	70.1	11
		38	9-1006-H	5.17	39.3	7.6	49.1	9.5	58.9	11	72.4	14
		44	9-1007-H	4.20	37.0	8.8	46.2	11	55.5	13	67.3	16
		51	9-1008-H	3.66	37.3	10	46.7	13	56.0	15	65.9	18
		64	9-1010-H	2.83	36.2	13	45.3	16	54.3	19	65.1	23
		76	9-1012-H	2.31	35.1	15	43.9	19	52.7	23	67.0	29
		89	9-1014-H	1.97	35.1	18	43.8	22	52.6	27	67.0	34
		102	9-1016-H	1.72	35.0	20	43.8	26	52.5	31	68.7	40
		305	9-1048-H	0.54	33.1	61	41.4	76	49.7	92	66.2	122

1 daN = 2.24 lbs. 1 mm = .0394 in.

METRIC



**EXTRA HEAVY LOAD**

Vacuum degassed,  
valve spring quality alloy steel

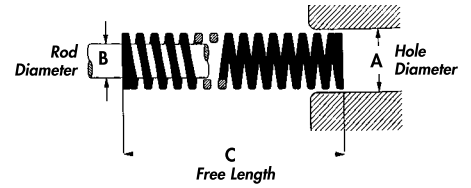

Sizes: 10 to 25 mm, Rectangular Wire Construction

Color: Yellow

Hole Dia. mm	Rod Dia. mm	Free Length mm	CATALOG NUMBER	KAIE Deka-newtons (daN) Required to Deflect 1 mm	LOAD - DEFLECTION TABLE							
					Total Deflection Recommended for Long Life (17% of C)		Total Deflection Recommended for Average Life (20% of C)		Maximum Operating Deflection (25% of C)		Total Travel to Solid	
					Load daN	Deflection mm	Load daN	Deflection mm	Load daN	Deflection mm	Load daN	Deflection mm
10	5	25	9-0604-X	3.25	13.8	4.3	16.3	5.0	20.3	6.3	29.3	9
		32	9-0605-X	2.51	13.7	5.4	16.1	6.4	20.1	8.0	25.1	10
		38	9-0606-X	2.09	13.5	6.5	15.9	7.6	19.9	9.5	27.2	13
		44	9-0607-X	1.79	13.4	7.5	15.8	8.8	19.7	11	26.9	15
		51	9-0608-X	1.50	13.0	8.7	15.3	10	19.1	13	25.5	17
		64	9-0610-X	1.20	13.1	11	15.4	13	19.2	16	25.2	21
		76	9-0612-X	1.00	12.9	13	15.2	15	19.0	19	26.0	26
		305	9-0648-X	0.24	12.4	52	14.6	61	18.3	76	25.4	106
12.5	6.3	25	9-0804-X	5.84	24.8	4.3	29.2	5.0	36.5	6.3	52.6	9
		32	9-0805-X	4.44	24.2	5.4	28.4	6.4	35.5	8.0	48.8	11
		38	9-0806-X	3.60	23.3	6.5	27.4	7.6	34.2	9.5	46.8	13
		44	9-0807-X	3.09	23.1	7.5	27.2	8.8	34.0	11	46.4	15
		51	9-0808-X	2.70	23.4	8.7	27.5	10	34.4	13	48.6	18
		64	9-0810-X	2.16	23.5	11	27.6	13	34.6	16	47.5	22
		76	9-0812-X	1.78	23.0	13	27.1	15	33.8	19	48.1	27
		305	9-0848-X	0.43	22.3	52	26.2	61	32.8	76	48.2	112
16	8	25	9-1004-X	12.6	53.3	4.3	62.8	5.0	78.4	6.3	113	9
		32	9-1005-X	9.28	50.5	5.4	59.4	6.4	74.2	8.0	102	11
		38	9-1006-X	7.49	48.4	6.5	56.9	7.6	71.2	9.5	97.4	13
		44	9-1007-X	6.30	47.1	7.5	55.4	8.8	69.3	11	94.5	15
		51	9-1008-X	5.51	47.8	8.7	56.2	10	70.3	13	99.2	18
		64	9-1010-X	4.29	46.7	11	54.9	13	68.6	16	94.4	22
		76	9-1012-X	3.53	45.6	13	53.7	15	67.1	19	91.8	27
		305	9-1048-X	0.85	44.3	52	52.1	61	65.2	76	94.0	110
20	10	25	9-1204-X	29.3	125	4.3	147	5.0	183	6.3	234	8
		32	9-1205-X	22.4	122	5.4	143	6.4	179	8.0	224	10
		38	9-1206-X	17.7	114	6.5	135	7.6	168	9.5	212	12
		44	9-1207-X	14.9	111	7.5	131	8.8	164	11	209	14
		51	9-1208-X	12.8	111	8.7	131	10	163	13	205	16
		64	9-1210-X	9.90	108	11	127	13	158	16	208	21
		76	9-1212-X	8.17	106	13	124	15	155	19	204	25
		89	9-1214-X	6.95	105	15	124	18	155	22	209	30
		102	9-1216-X	6.06	105	17	124	20	155	26	206	34
		115	9-1218-X	5.30	104	20	122	23	152	29	201	38
		127	9-1220-X	4.76	103	22	121	25	151	32	205	43
		140	9-1222-X	4.30	102	24	120	28	151	35	202	47
		305	9-1224-X	3.90	101	26	119	30	148	38	199	51
25	9-1248-X	2.12	110	52	129	61	162	76	223	105		
25	12.5	32	9-1605-X	35.4	193	5.4	227	6.4	283	8.0	354	10
		38	9-1606-X	28.0	181	6.5	213	7.6	266	9.5	336	12
		44	9-1607-X	23.2	173	7.5	204	8.8	255	11	325	14
		51	9-1608-X	19.8	171	8.7	202	10	252	13	316	16
		64	9-1610-X	15.4	167	11	197	13	246	16	323	21
		76	9-1612-X	12.5	162	13	190	15	238	19	313	25
		89	9-1614-X	10.6	160	15	188	18	235	22	306	29
		102	9-1616-X	9.12	158	17	186	20	233	26	310	34
		115	9-1618-X	8.11	159	20	187	23	233	29	316	39
		127	9-1620-X	7.21	156	22	183	25	229	32	310	43
		140	9-1622-X	6.55	156	24	183	28	229	35	314	48
		152	9-1624-X	6.01	155	26	183	30	228	38	319	53
		178	9-1628-X	5.13	155	30	183	36	228	45	318	62
		203	9-1632-X	4.47	154	35	181	41	227	51	313	70
		305	9-1648-X	2.96	153	52	181	61	226	76	320	108

1 daN = 2.24 lbs. 1 mm = .0394 in.

Hole Dia. mm	Rod Dia. mm	Free Length mm	CATALOG NUMBER	RATE Dekanewtons (daN) Required to Deflect 1 mm	LOAD - DEFLECTION TABLE							
					Total Deflection Recommended for Long Life (17% of C)		Total Deflection Recommended for Average Life (20% of C)		Maximum Operating Deflection (25% of C)		Total Travel to Solid	
					Load daN	Deflection mm	Load daN	Deflection mm	Load daN	Deflection mm	Load daN	Deflection mm
32	16	38	9 - 2006 - X	48.9	316	6.5	372	7.6	464	9.5	538	11
		44	9 - 2007 - X	40.5	303	7.5	356	8.8	445	11	526	13
		51	9 - 2008 - X	34.6	300	8.7	352	10	441	13	518	15
		64	9 - 2010 - X	26.7	291	11	342	13	427	16	534	20
		76	9 - 2012 - X	21.6	279	13	328	15	410	19	518	24
		89	9 - 2014 - X	18.2	276	15	325	18	406	22	529	29
		102	9 - 2016 - X	15.6	271	17	319	20	398	26	515	33
		115	9 - 2018 - X	13.6	267	20	314	23	392	29	491	36
		127	9 - 2020 - X	12.2	264	22	310	25	388	32	501	41
		140	9 - 2022 - X	11.2	266	24	313	28	391	35	525	47
		152	9 - 2024 - X	10.1	262	26	308	30	385	38	507	50
		178	9 - 2028 - X	8.58	260	30	305	36	382	45	506	59
		203	9 - 2032 - X	7.50	259	35	305	41	381	51	510	68
		254	9 - 2040 - X	5.98	258	43	304	51	380	64	508	85
305	9 - 2048 - X	4.96	257	52	303	61	378	76	511	103		
40	20	51	9 - 2408 - X	56.0	485	8.7	571	10	714	13	840	15
		64	9 - 2410 - X	42.2	459	11	540	13	674	16	801	19
		76	9 - 2412 - X	33.8	437	13	514	15	643	19	812	24
		89	9 - 2414 - X	28.2	427	15	503	18	628	22	790	28
		102	9 - 2416 - X	24.4	424	17	499	20	623	26	807	33
		115	9 - 2418 - X	21.4	418	20	491	23	614	29	791	37
		127	9 - 2420 - X	19.0	410	22	483	25	603	32	779	41
		140	9 - 2422 - X	17.1	407	24	479	28	599	35	787	46
		152	9 - 2424 - X	15.6	402	26	473	30	591	38	778	50
		178	9 - 2428 - X	13.2	398	30	468	36	585	45	763	58
		203	9 - 2432 - X	11.4	393	35	462	41	578	51	763	67
		254	9 - 2440 - X	9.06	391	43	460	51	575	64	770	85
		305	9 - 2448 - X	7.52	390	52	459	61	573	76	767	102
		50	25	64	9 - 3210 - X	72.4	788	11	927	13	1158	16
76	9 - 3212 - X			57.3	740	13	871	15	1088	19	1317	23
89	9 - 3214 - X			47.4	717	15	844	18	1055	22	1280	27
102	9 - 3216 - X			40.4	701	17	825	20	1031	26	1254	31
115	9 - 3218 - X			35.3	689	20	811	23	1014	29	1234	35
127	9 - 3220 - X			31.3	675	22	794	25	992	32	1219	39
140	9 - 3222 - X			28.1	669	24	787	28	984	35	1237	44
152	9 - 3224 - X			23.9	618	26	727	30	908	38	1123	47
178	9 - 3228 - X			21.5	650	30	765	36	956	45	1203	56
203	9 - 3232 - X			18.6	641	35	754	41	943	51	1189	64
254	9 - 3240 - X			14.6	631	43	743	51	929	64	1170	80
305	9 - 3248 - X			12.1	626	52	736	61	920	76	1170	97

1 daN = 2.24 lbs. 1 mm = .0394 in.

METRIC

SPRING CAGES

## Spring Cages

- black oxide finish
- made of rolled, cold steel

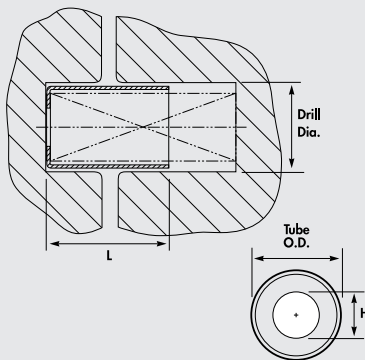

Spring O.D.	Drill Dia.	Tube O.D.	H
<b>Inch</b>			
3/4	29/32	.855	7/16
1	1 5/32	1.105	9/16
1 1/4	1 13/32	1.355	3/4
1 1/2	1 21/32	1.605	31/32
2	2 5/32	2.105	1 3/8
<b>Metric</b>			
20	24	21.7	11
25	30	28.0	14
32	36	34.4	19
40	43	40.8	25
50	56	53.4	35

L (inch)	CATALOG NUMBERS				
	3/4 O.D.	1 O.D.	1 1/4 O.D.	1 1/2 O.D.	2 O.D.
1.00	6 - 8	8 - 8	10 - 8		
1.25	6 - 10	8 - 10	10 - 10	12 - 10	16 - 10
1.50	6 - 12	8 - 12	10 - 12	12 - 12	16 - 12
1.75	6 - 14	8 - 14	10 - 14	12 - 14	16 - 14
2.00	6 - 16	8 - 16	10 - 16	12 - 16	16 - 16
2.25	6 - 18	8 - 18	10 - 18	12 - 18	16 - 18
2.50	6 - 20	8 - 20	10 - 20	12 - 20	16 - 20
2.75	6 - 22	8 - 22	10 - 22	12 - 22	16 - 22
3.00	6 - 24	8 - 24	10 - 24	12 - 24	16 - 24
3.25	6 - 26	8 - 26	10 - 26	12 - 26	16 - 26
3.50	6 - 28	8 - 28	10 - 28	12 - 28	16 - 28
3.75	6 - 30	8 - 30	10 - 30	12 - 30	16 - 30
4.00	6 - 32	8 - 32	10 - 32	12 - 32	16 - 32
4.25	6 - 34	8 - 34	10 - 34	12 - 34	16 - 34
4.50	6 - 36	8 - 36	10 - 36	12 - 36	16 - 36
4.75	6 - 38	8 - 38	10 - 38	12 - 38	16 - 38
5.00	6 - 40	8 - 40	10 - 40	12 - 40	16 - 40
5.50	6 - 44	8 - 44	10 - 44	12 - 44	16 - 44
6.00	6 - 48	8 - 48	10 - 48	12 - 48	16 - 48
6.50	6 - 52	8 - 52	10 - 52	12 - 52	16 - 52
7.00	6 - 56	8 - 56	10 - 56	12 - 56	16 - 56
8.00	6 - 64	8 - 64	10 - 64	12 - 64	16 - 64
9.00			10 - 72	12 - 72	16 - 72
10.00			10 - 80	12 - 80	16 - 80
11.00					16 - 88
12.00					16 - 96

L (mm)	CATALOG NUMBERS				
	20 O.D.	25 O.D.	32 O.D.	40 O.D.	50 O.D.
25	20 - 25	25 - 25	32 - 25		
32	20 - 32	25 - 32	32 - 32	40 - 32	50 - 32
38	20 - 38	25 - 38	32 - 38	40 - 38	50 - 38
44	20 - 44	25 - 44	32 - 44	40 - 44	50 - 44
51	20 - 51	25 - 51	32 - 51	40 - 51	50 - 51
57	20 - 57	25 - 57	32 - 57	40 - 57	50 - 57
64	20 - 64	25 - 64	32 - 64	40 - 64	50 - 64
70	20 - 70	25 - 70	32 - 70	40 - 70	50 - 70
76	20 - 76	25 - 76	32 - 76	40 - 76	50 - 76
83	20 - 83	25 - 83	32 - 83	40 - 83	50 - 83
89	20 - 89	25 - 89	32 - 89	40 - 89	50 - 89
95	20 - 95	25 - 95	32 - 95	40 - 95	50 - 95
102	20 - 102	25 - 102	32 - 102	40 - 102	50 - 102
108	20 - 108	25 - 108	32 - 108	40 - 108	50 - 108
114	20 - 114	25 - 114	32 - 114	40 - 114	50 - 114
121	20 - 121	25 - 121	32 - 121	40 - 121	50 - 121
127	20 - 127	25 - 127	32 - 127	40 - 127	50 - 127
140	20 - 140	25 - 140	32 - 140	40 - 140	50 - 140
152	20 - 152	25 - 152	32 - 152	40 - 152	50 - 152
165	20 - 165	25 - 165	32 - 165	40 - 165	50 - 165
178	20 - 178	25 - 178	32 - 178	40 - 178	50 - 178
203	20 - 203	25 - 203	32 - 203	40 - 203	50 - 203
229	20 - 229	25 - 229	32 - 229	40 - 229	50 - 229
254	20 - 254	25 - 254	32 - 254	40 - 254	50 - 254
279					50 - 279
305					50 - 305



## The Innovator of Our Industry<sup>SM</sup>

Our factories and offices:

U.S.A. • U.K. • France • Belgium • Germany • Sweden • Netherlands • Singapore

**READY TECHNOLOGY, INC.**

333 Progress Rd. • Dayton, OH 45449  
 (800) 543-4355 • (937) 866-7200 • fax (937) 866-7226

[www.readytechnology.com](http://www.readytechnology.com)